

Surgical Technique

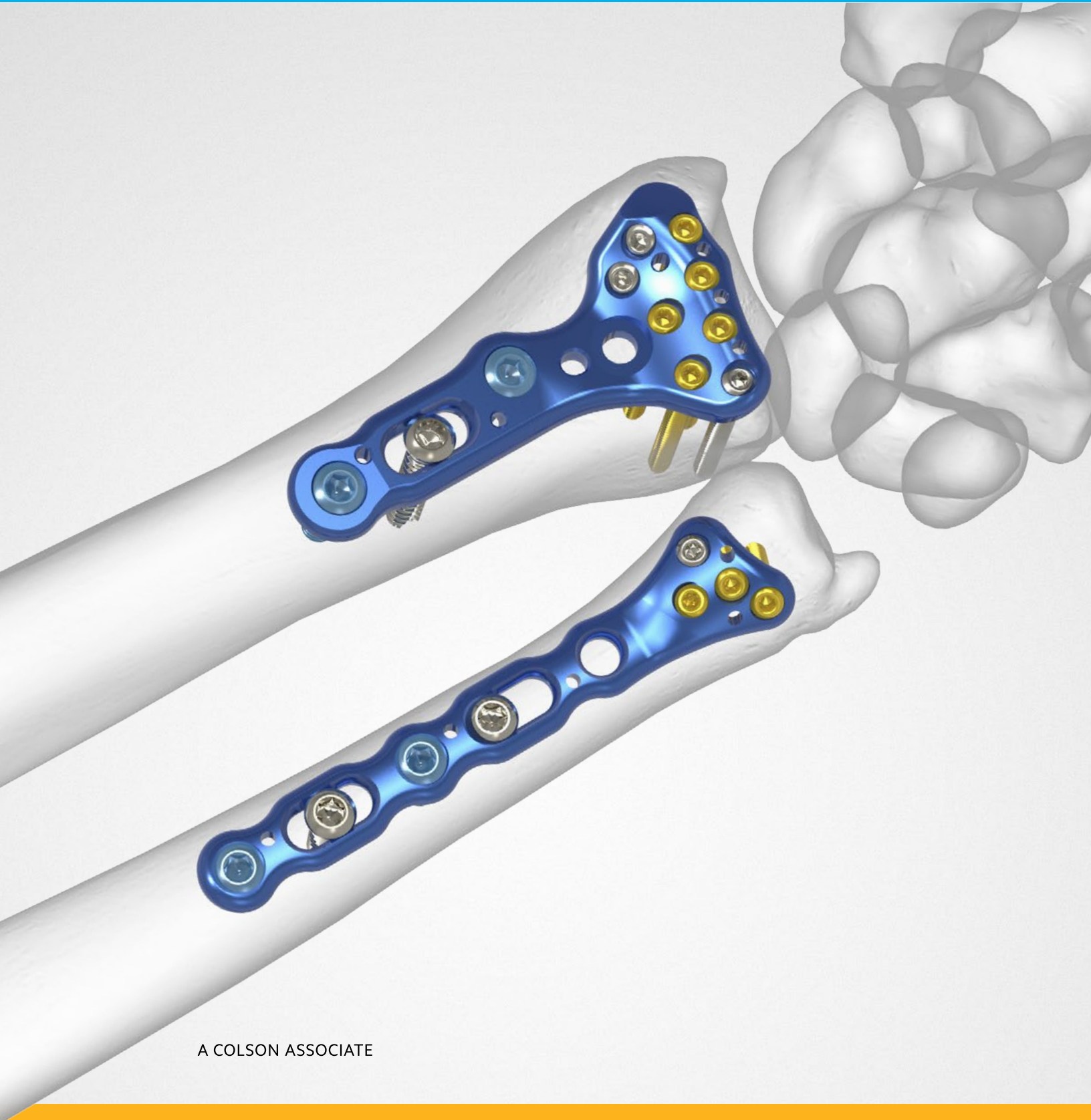

Acumed® is a global leader of innovative orthopaedic and medical solutions.



We are dedicated to developing products, service methods, and approaches that improve patient care.



Acumed® Acu-Loc® Wrist Plating System

In 2004, Acumed introduced the Acu-Loc Targeted Volar Distal Radius Plate System for repairing fractures of the distal radius. Since its release, over 200,000 Acu-Loc Volar Distal Radius Plates have been implanted globally.

To further assist with complications of wrist fractures, osteotomies, and other wrist injuries, Acumed has introduced three additional plate families to the system: the **Acu-Loc Dorsal Plates**, the **Acu-Loc Extra-Articular (EX) Plates**, and the **Acu-Loc Volar Distal Ulna (VDU) Plates**.

The locking Acu-Loc Dorsal Plates offer a solution to treat distal radius fractures that need to be addressed from the dorsal side.

The Acu-Loc EX Plates provide an option for extra-articular fractures and osteotomies.

The Acu-Loc VDU Plates are designed specifically for periarticular fractures of the distal ulna. The screw positioning and angulation targets distal fragments of the ulnar head and neck.

	Definition
Warning	Indicates critical information about a potential serious outcome to the patient or the user.
Caution	Indicates instructions that must be followed in order to ensure the proper use of the device.
Note	Indicates information requiring special attention.

Table of Contents

System Features	2
Instrument Overview	6
Surgical Technique Overview	8
Surgical Techniques	10
Acu-Loc Volar Plate Technique	10
Acu-Loc Dorsal Plate Technique	14
Acu-Loc EX Plate Technique	18
Acu-Loc VDU Plate Technique	22
Ordering Information	26

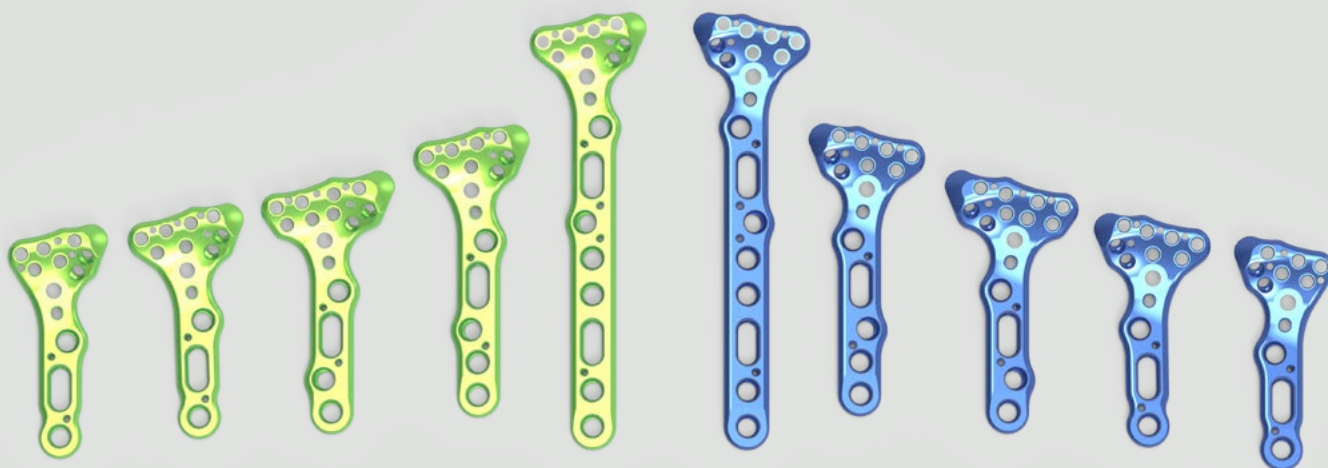

System Features

Acu-Loc Volar Distal Radius Plate

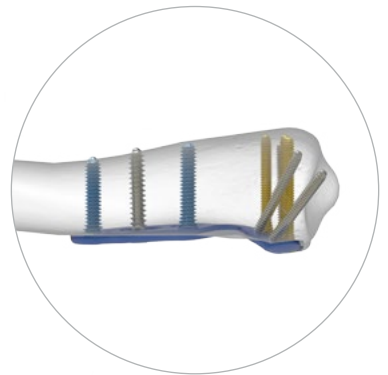

.054" K-wire holes are in line with distal 2.3 mm screws to assist with screw placement

Targeted radial styloid screws

Mounting holes for targeting guide

Locking divergent shaft screw holes

K-wire holes

Linear Leg Travel

Typical Uses:

- ▶ Intra-articular fractures
- ▶ Extra-articular fractures
- ▶ Corrective osteotomy



System Features [continued]

Acu-Loc VDU Plate

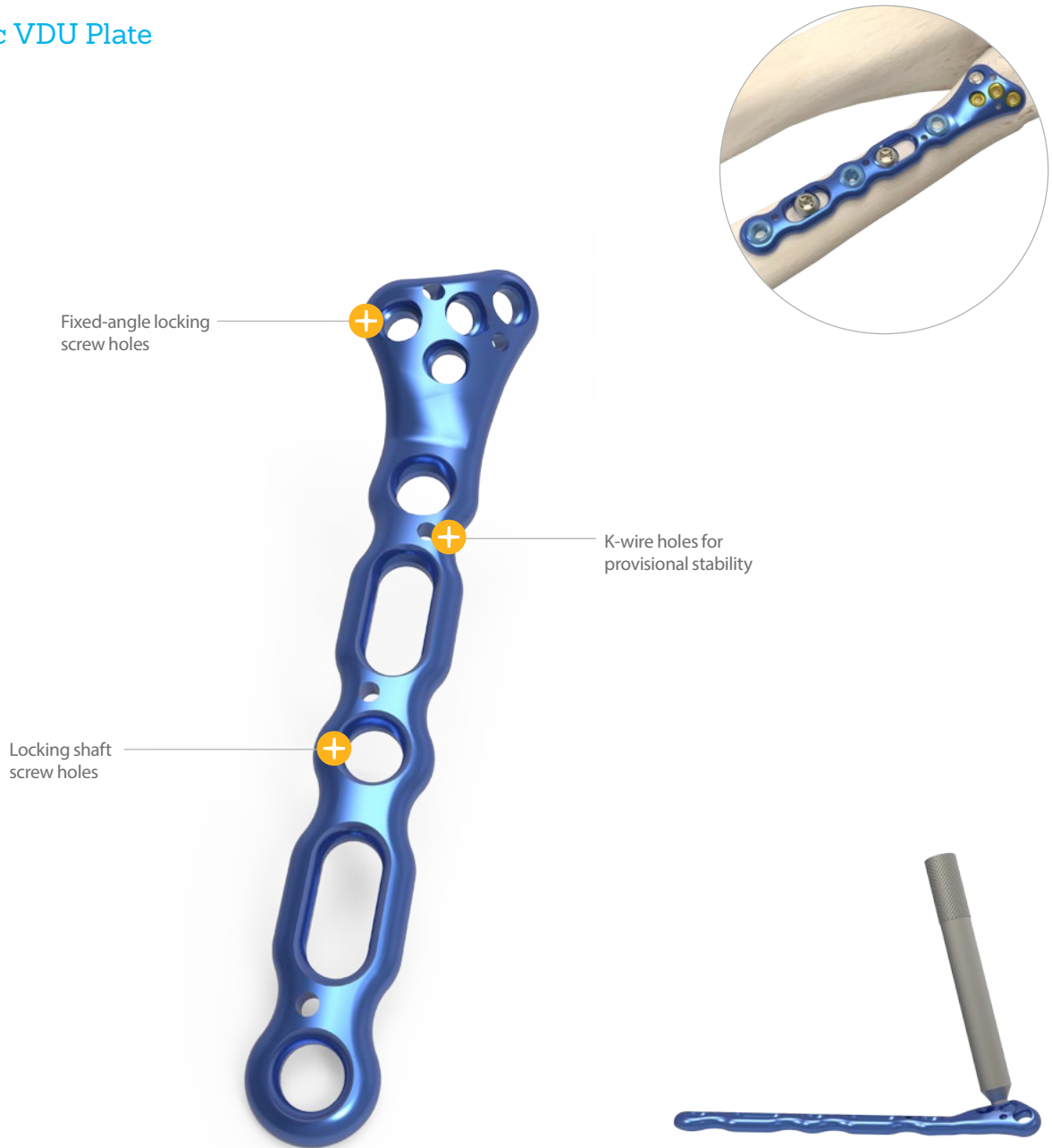

Acu-Loc® VDU Long Plate pictured

Typical Uses:

- ▶ Distal ulna shaft fractures
- ▶ Ulna neck fractures
- ▶ Periarticular ulna head fractures

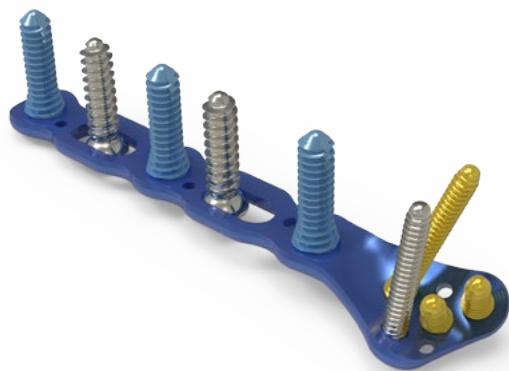

System Features [continued]

Acu-Loc EX Plate

Typical Uses:

- ▶ Extra-articular fractures
- ▶ Corrective osteotomy
- ▶ “Flat” radius



Acu-Loc® EX Standard Plate pictured

System Features [continued]

Acu-Loc Dorsal Plate

Typical Uses:

- ▶ Buttress for dorsal fractures
- ▶ Corrective osteotomy
- ▶ Dorsal comminution

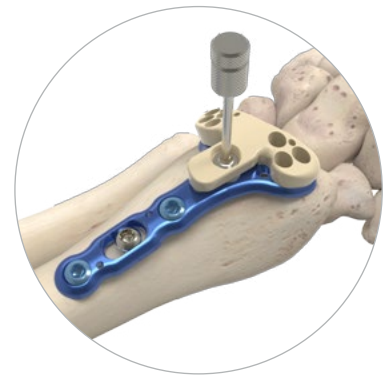

Acu-Loc® Dorsal Standard Plate pictured

Instrument Overview



Acu-Loc Dorsal Targeting Guide Standard, Left
(80-0150)



Acu-Loc® Dorsal Targeting Guide Standard, Right
(80-0151)



Acu-Loc Dorsal Targeting Guide, Narrow, Left
(80-0154)



Acu-Loc Dorsal Targeting Guide, Narrow, Right
(80-0155)



Acu-Loc EX Targeting Guide, Standard
(80-0166)



Acu-Loc EX Targeting Guide, Narrow
(80-0274)



Radiolucent VDR Targeting Guide, Narrow, Left
(80-0051)



Radiolucent VDR Targeting Guide, Narrow, Right
(80-0052)



Radiolucent VDR Targeting Guide, Standard, Left
(80-0028)



Radiolucent VDR Targeting Guide, Standard, Right
(80-0029)



Radiolucent VDR Targeting Guide, Wide, Left
(80-0047)



Radiolucent VDR Targeting Guide, Wide, Right
(80-0048)



Distal Radius Probe
(MS-DRPB)

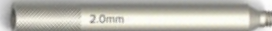

Drill Guide for Distal Screws
(MS-LDG23)



Drill Guide/Depth Gauge for 2.0 mm Drill
(MS-DG23)



Locking Screw, Acu-Loc Radiolucent Targeting Guide
(80-0038)



1.5 mm Hex Driver Tip (Small Shaft)
(HPC-0015)



2.3 mm Screw Sleeve
(MS-SS23)

Instrument Overview [continued]

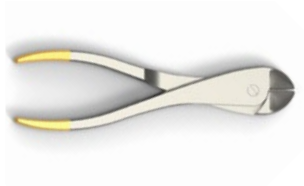

Wire Cutter (.062")
(MS-46621)



Reduction Forceps With Serrated Jaw
(PL-CL04)



Small Pointed Reduction Forceps
(OW-1200)

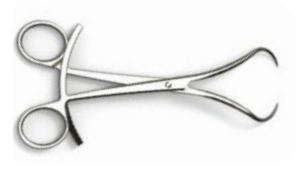

8" Bone Reduction Forceps
(MS-1280)



6 mm–70 mm Depth Gauge
(MS-9020)



2.5 mm Quick Release Hex Driver
(HPC-0025)



3.5 mm Screw Driver Sleeve
(MS-SS35)



3.5 mm Locking Drill Guide
(MS-LDG35)



Large Cannulated Quick Release Driver Handle
(MS-3200)



2.8 mm x 5" Quick Release Drill
(MS-DC28)



Congruent Drill Guide
(PL-2018)



Large Screw Holding Forceps
(MS-45210)



Sharp Hook
(PL-CL06)



.054" x 6" Guide Wire
(WS-1406ST)



.045" x 6" ST Guide Wire
(WS-1106ST)



Periosteal Elevator
(MS-46212)



15 mm Hohmann Retractor
(MS-46827)



Plate Bender, Large
(PL-2045)



2.0 mm Drill for Distal Radius
(MS-DCR20)



Cruciform Driver Handle
(MS-2210)

Surgical Technique Overview

Acu-Loc Volar Plate Technique

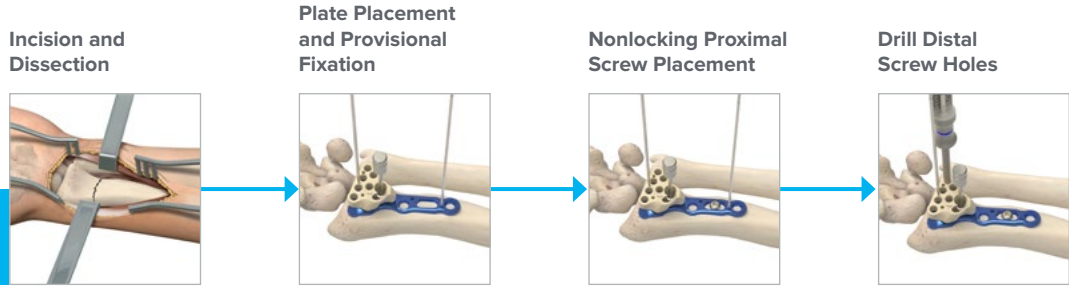

Acu-Loc Dorsal Plate Technique

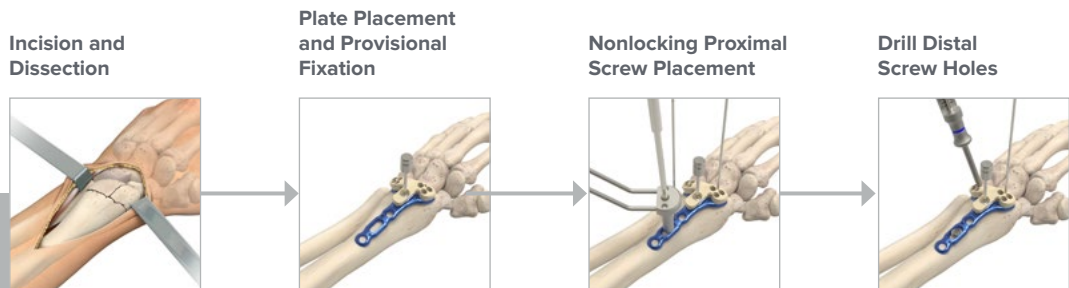

Acu-Loc EX Plate Technique

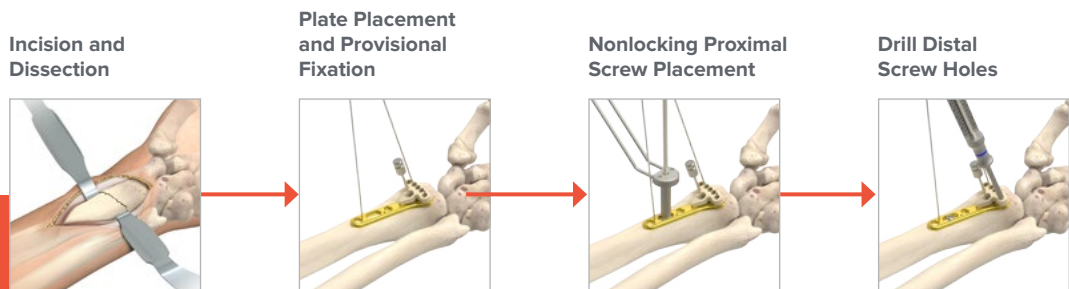

Acu-Loc VDU Plate Technique

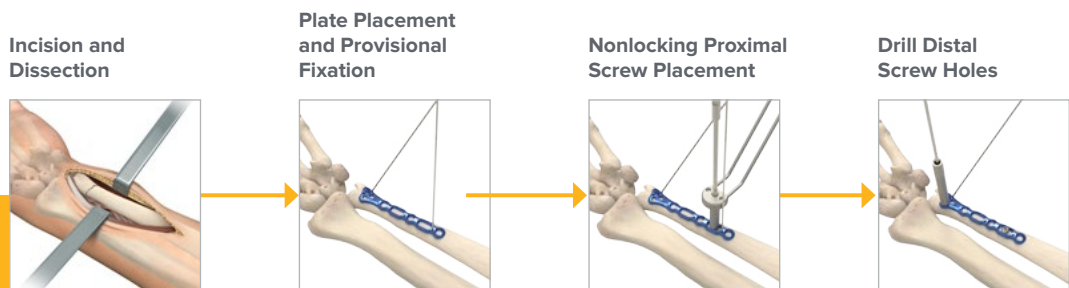

Distal Screw Selection



Distal Screw Placement



Styloid Screw Placement



Proximal Locking Screw Placement



Closure and Postoperative Protocol



Distal Screw Selection and Placement

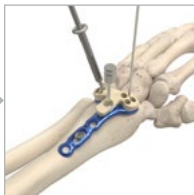

Proximal Locking Screw Placement

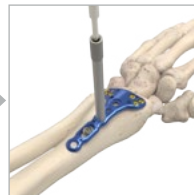

Closure and Postoperative Protocol



Distal Screw Selection and Placement

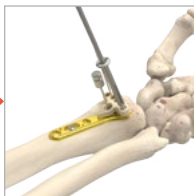

Proximal Locking Screw Placement

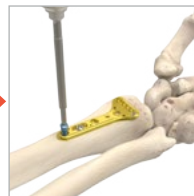

Closure and Postoperative Protocol



Distal Screw Selection



Proximal Locking Screw Placement



Closure and Postoperative Protocol



Acu-Loc Volar Plate Technique

William B. Geissler, MD

1 Incision and Dissection

Supinate the patient's forearm to expose the surgical site. To maximize exposure, position a towel under the wrist, placing it in extension. Make a longitudinal incision approximately six centimeters in length just radial to the FCR tendon to protect against injury to the palmar cutaneous branch of the median nerve.

Open the tendon sheath and retract the tendon radially to protect the radial artery. Identify the flexor pollicus longus by passive flexion/extension of the thumb interphalangeal joint and retract ulnarly to protect the median nerve. Next, identify the pronator quadratus by its transverse fibers and release radially to the ulnar to expose the fracture site.

2 Plate Placement and Provisional Fixation

Reduce the fracture and evaluate under fluoroscopy.

The brachioradialis may need to be released from its insertion on the radial styloid to facilitate reduction and visualization of the fracture. The Acu-Loc VDR Plate (PL-DRXXX) is designed to sit along the distal aspect of the radius to support the volar articular fracture fragments. Once the appropriate plate is selected, attach the corresponding Radiolucent VDR Targeting Guide (80-00XX) using the Locking Screw, Acu-Loc Radiolucent Targeting Guide (80-0038). This may be done on the back table prior to insertion. Then secure the plate's position proximally with a .045" x 6" K-wire (WS-1106ST) and distally with a .054" x 6" K-wire (WS-1406ST). If the targeting guide is not already attached to the plate, slide the guide over the distal K-wire and into position. Another method is to secure the plate to the bone with a cortical screw proximally and then attach the targeting guide.

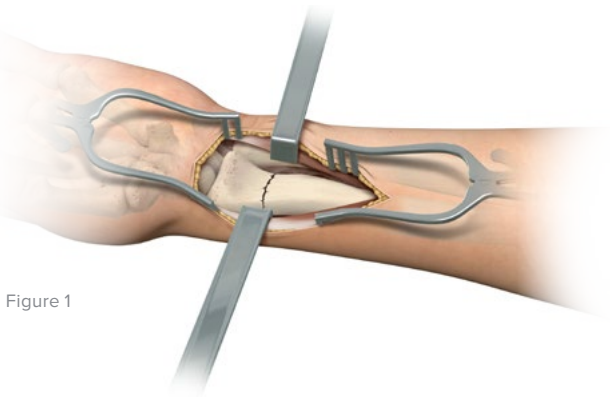

Figure 1

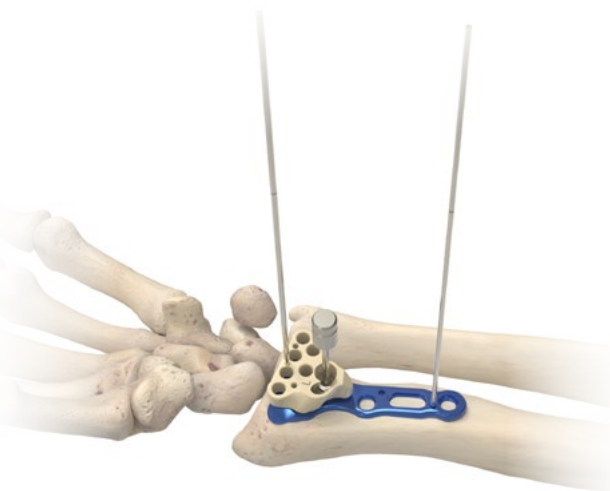

Figure 2



Acu-Loc VDR Plate (PL-DRXXX)



Radiolucent VDR Targeting Guide (80-00XX)



Locking Screw, Acu-Loc Radiolucent Targeting Guide (80-0038)



.045" x 6" ST Guide Wire (WS-1106ST) Also used as a K-wire



.054" x 6" Guide Wire (WS-1406ST) Also used as a K-wire

Acu-Loc Volar Plate Technique [continued]

3 Nonlocking Proximal Screw Placement

The first nonlocking 3.5 mm Cortical Screw (CO-31X0) is placed through the slot in the plate by first drilling bicortically with the 2.8 mm x 5" Quick Release Drill (MS-DC28) and the Congruent Drill Guide (PL-2018). Measure the drill depth with the 6 mm–70 mm Depth Gauge (MS-9020) and insert the appropriate silver 3.5 mm cortical screw, taking care that the screw is the proper length.

Note: Small adjustments to the position of the plate relative to the articular surface can now be done by sliding the plate proximally or distally under fluoroscopy.

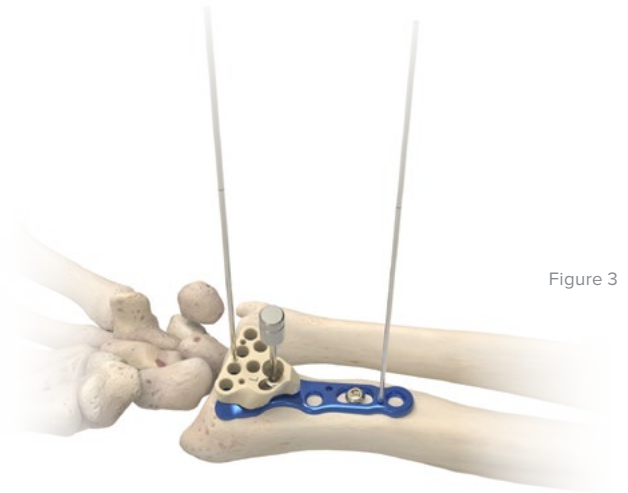

Figure 3

4 Drill Distal Screw Holes

To assess the position of the distal locking screws relative to the articular surface and the dorsum of the radius, a .054" x 6" K-wire (WS-1406ST) may be placed through the distal K-wire holes on the Radiolucent VDR Targeting Guide (80-00XX) and plate. Under fluoroscopy, assess the fracture reduction, the plate position, and the location of the K-wire relative to the joint. If the distal K-wires do not penetrate the joint, the distal 2.3 mm screws will not either. Target one of the four distal holes first. Insert the Drill Guide/Depth Gauge for 2.0 mm Drill (MS-DG23) into one of the holes, followed by the 2.0 mm Drill for Distal Radius (MS-DCR20). Measure the screw length by using the laser mark on the drill and the scale on the drill guide. As an alternative, the Distal Radius Probe (MS-DRPB) may be used by hooking the far cortex and measuring with the laser mark on the probe.



Figure 4

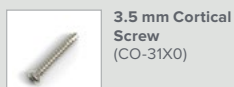

3.5 mm Cortical Screw
(CO-31X0)



2.8 mm x 5" Quick Release Drill
(MS-DC28)



Congruent Drill Guide
(PL-2018)



6 mm–70 mm Depth Gauge
(MS-9020)



.054" x 6" Guide Wire
(WS-1406ST)
Also used as a K-wire



Radiolucent VDR Targeting Guide
(80-00XX)



Drill Guide/
Depth Gauge for
2.0 mm Drill
(MS-DG23)



2.0 mm Drill for
Distal Radius
(MS-DCR20)



Distal Radius Probe
(MS-DRPB)

Acu-Loc Volar Plate Technique [continued]



Figure 5



Figure 6



Figure 7

5 Distal Screw Selection

There are three types of 2.3 mm screws that can be used in any of the eight distal holes: Locking Cortical Screws (gold), Locking Cortical Pegs (bronze), and Nontoggling Cortical Screws (silver). Insert all 2.3 mm screws using the 1.5 mm Hex Driver Tip (HPC-0015), the 2.3 mm Screw Sleeve (MS-SS23), and the Cruciform Driver Handle (MS-2210).

Note: A Drill Guide for Distal Screws (MS-LDG23) is available in the system as an alternative for drilling the distal holes. The screw length can be read using the 6 mm–70 mm Depth Gauge (MS-9020).

6 Distal Screw Placement

It is at the discretion of the surgeon when to use the Locking Cortical Screws, the Locking Cortical Pegs, and the Nontoggling (nonlocking) Cortical Screws. The thread pitch on the Locking Cortical Screw is the same from the tip to the head, minimizing the “differential pitch effect” as the screw is seated into the plate. All eight distal holes accept the three different screw designs.

Note: A minimum of six distal screws should be used in the four most distal holes and the two radial styloid holes.

7 Styloid Screw Placement

The radial styloid screws are designed specifically to target and support the radial styloid fragment at angles of 41 and 53 degrees from the plate. Approach the two radial styloid screws from the back of the targeting guide. Using the dual slot on the back of the guide, target the distal/radial screw by inserting the Drill Guide/Depth Gauge for 2.0 mm Drill (MS-DG23) into the radial side of the dual slot. Target the more proximal/ulnar screw by inserting the drill guide into the ulnar side of the dual slot. Both radial styloid screws should be drilled through the targeting guide. Remove the guide to measure and insert the screws. With the targeting guide in place, it may be difficult to remove the radial styloid screws if a different size screw is needed. If resizing is necessary, remove the guide and the screw, measure with the 6 mm–70 mm Depth Gauge (MS-9020), and insert the proper screw.



1.5 mm Hex Driver Tip (Small Shaft) (HPC-0015)



2.3 mm Screw Sleeve (MS-SS23)



Cruciform Driver Handle (MS-2210)



Drill Guide for Distal Screws (MS-LDG23)



6 mm–70 mm Depth Gauge (MS-9020)



Drill Guide/Depth Gauge for 2.0 mm Drill (MS-DG23)

Acu-Loc Volar Plate Technique [continued]

8 Proximal Locking Screw Placement

Select one of the two remaining proximal holes and insert the 3.5 mm Locking Drill Guide (MS-LDG35). Drill with the 2.8 mm x 5" Quick Release Drill (MS-DC28) and measure with the 6 mm–70 mm Depth Gauge (MS-9020). Insert the proper length 3.5 mm Locking Cortical Screw (COL-3XX0) using the 2.5 mm Quick Release Hex Driver (HPC-0025), the 3.5 mm Screw Driver Sleeve (MS-SS35), and the Large Cannulated Quick Release Driver Handle (MS-3200). Using the same process, drill and place the final locking screw.

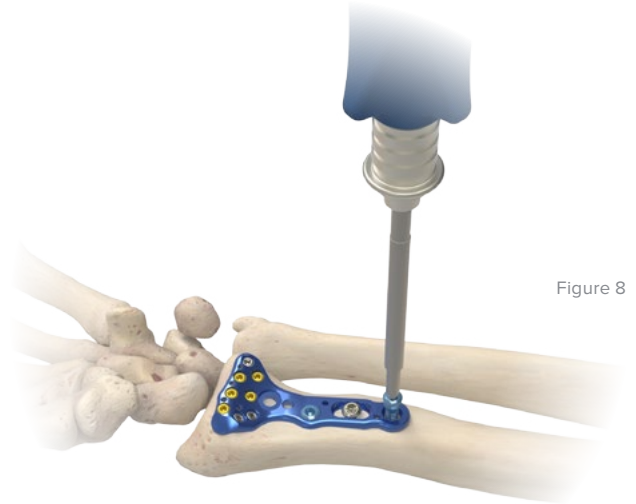

Figure 8

9 Closure and Postoperative Protocol

Closing and postoperative protocol are at the discretion of the surgeon. The following protocol is provided as an example:

Following thorough radiographic evaluation, check alignment and rotation, then close. Start immediate finger range of motion and forearm rotation post-op. Allow early functional use of the hand for light activities of daily living. Support the wrist according to bone quality and stability.

10 Optional: Implant Removal Instructions

To extract an Acu-Loc Volar Plate, use the 2.5 mm Quick Release Hex Driver (HPC-0025) and Large Cannulated Quick Release Driver Handle (MS-3200) to remove all the 3.5 mm screws in the plate. Use the 1.5 mm Hex Driver Tip and Locking Groove (80-0728) with Cruciform Driver Handle (MS-2210) for the 2.3 mm screws.

Referencing the Screw Removal Brochure (SPF10-00) may aid in implant extraction if difficulty is experienced.



Acu-Loc Dorsal Plate Technique

William B. Geissler, MD

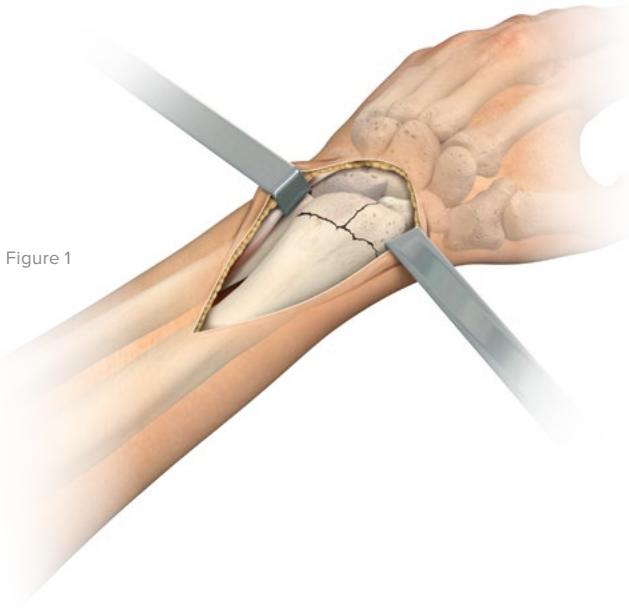

Figure 1

1 Incision and Dissection

Make the dorsal approach incision in line with Lister's tubercle and the radial border of the long finger. Carry down blunt dissection to protect the dorsal cutaneous nerve branches. Identify the extensor pollicis longus tendon distally in the wound and release through the third dorsal compartment. Then subperiostally elevate the second and fourth compartments. Use caution when elevating the second and fourth dorsal compartments as bone fragments may have adhered to their undersurface.

A neurectomy of the posterior interosseous nerve may then be performed at the surgeon's discretion. Identify the posterior interosseous nerve on the radial aspect of the fourth compartment as it is elevated. A neurectomy is recommended on the proximal aspect of the incision to decrease neuroma pain.

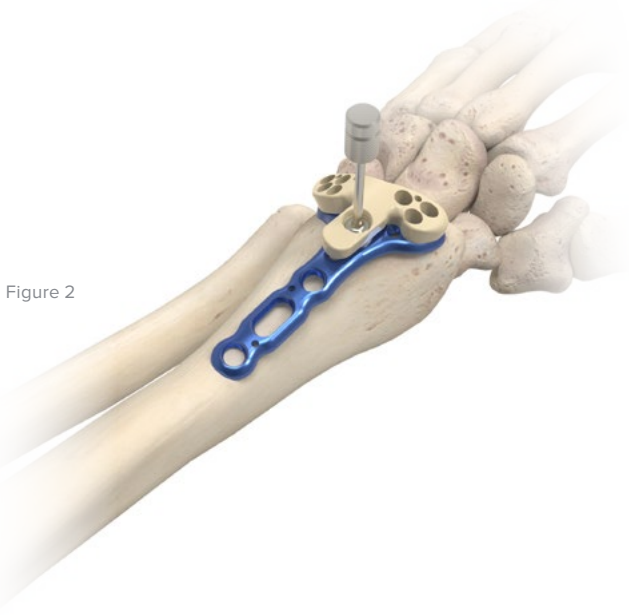

Figure 2

2 Plate Placement and Provisional Fixation

Anatomically reduce the fracture with traction and volar translation. The Acu-Loc Dorsal Plate (70-005X) can be used as a buttress to help push and reduce the dorsal displaced fracture fragments volarly. Verify the reduction of the fracture and correct plate position under fluoroscopy, then provisionally stabilize the plate with K-wires. Place the proximal shaft of the plate just radial to the most convex position of the radial shaft. The appropriate right or left Acu-Loc Dorsal Targeting Guide (80-015X) may be attached to the appropriate plate on the back table prior to insertion and then placed on the bone.



Acu-Loc Dorsal Plate (70-005X)



Acu-Loc Dorsal Targeting Guide (80-015X)

Acu-Loc Dorsal Plate Technique [continued]

3 Nonlocking Proximal Screw Placement

The first nonlocking 3.5 mm Cortical Screw (CO-31X0) is placed through the slot in the plate by first drilling bicortically with the 2.8 mm x 5" Quick Release Drill (MS-DC28) and the Congruent Drill Guide (PL-2018). Measure the drill depth with the 6 mm–70 mm Depth Gauge (MS-9020) and insert the appropriate silver 3.5 mm cortical screw, taking care that the screw is the proper length.

Note: Small adjustments to the position of the plate relative to the articular surface can now be done by sliding the plate proximally or distally under fluoroscopy.

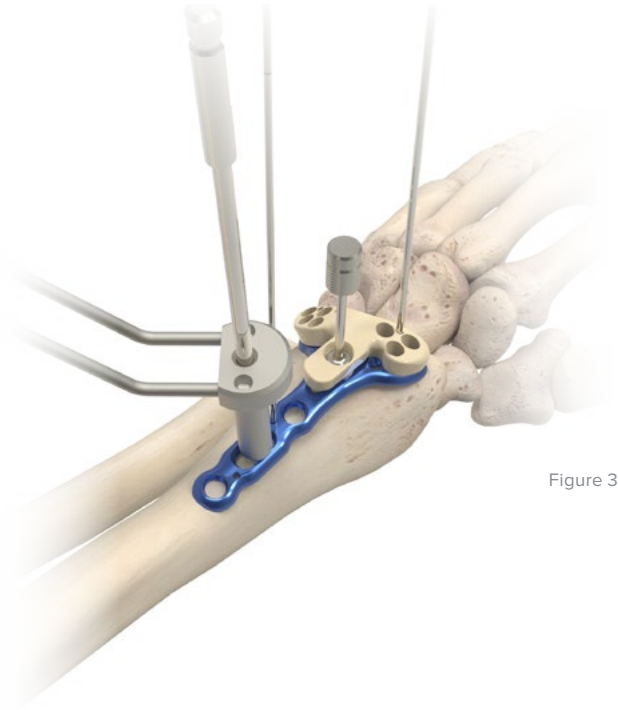

Figure 3

4 Drill Distal Screw Holes

To assess the position of the distal locking screws relative to the articular surface and the dorsum of the radius, a .054" K-wire (WS-1406ST) may be placed through the distal K-wire holes on the Acu-Loc Dorsal Targeting Guide (80-015X) and plate. The fracture reduction, the plate position, and the location of the K-wire relative to the joint is assessed under fluoroscopy. If the distal K-wires do not penetrate the joint, the distal 2.3 mm screws will not either. Care should be taken not to angle the distal K-wires.

Select one of the four distal screw holes closest to the joint to drill first. Insert the Drill Guide/Depth Gauge for 2.0 mm Drill (MS-DG23) into the selected hole followed by the 2.0 mm Drill for Distal Radius (MS-DCR20). Measure the depth of the screw using the laser mark on the drill shaft and scale on the drill guide. As an alternative, the Distal Radius Probe (MS-DRPB) may be used by hooking the far cortex and measuring with the laser mark on the probe.

Note: A Drill Guide for Distal Screws (MS-LDG23) is available as an alternative for drilling the distal screw holes. The depth of the hole can be measured using the 6 mm–70 mm Depth Gauge (MS-9020).

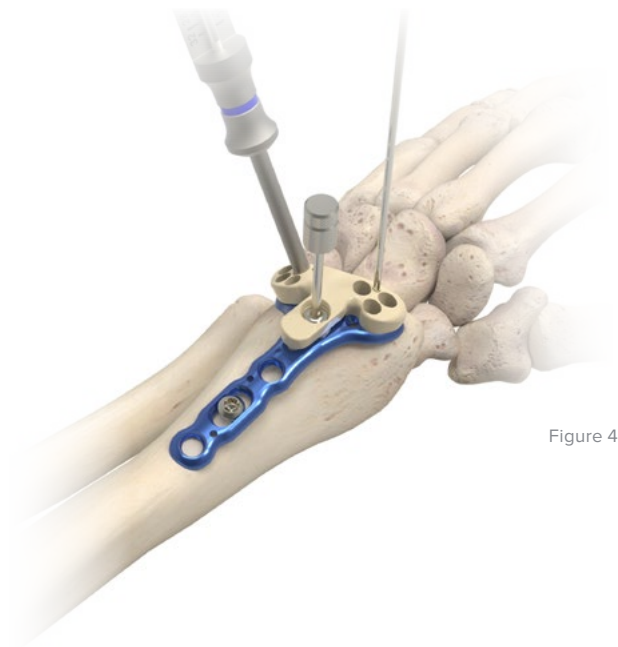

Figure 4



Acu-Loc Dorsal Plate Technique [continued]

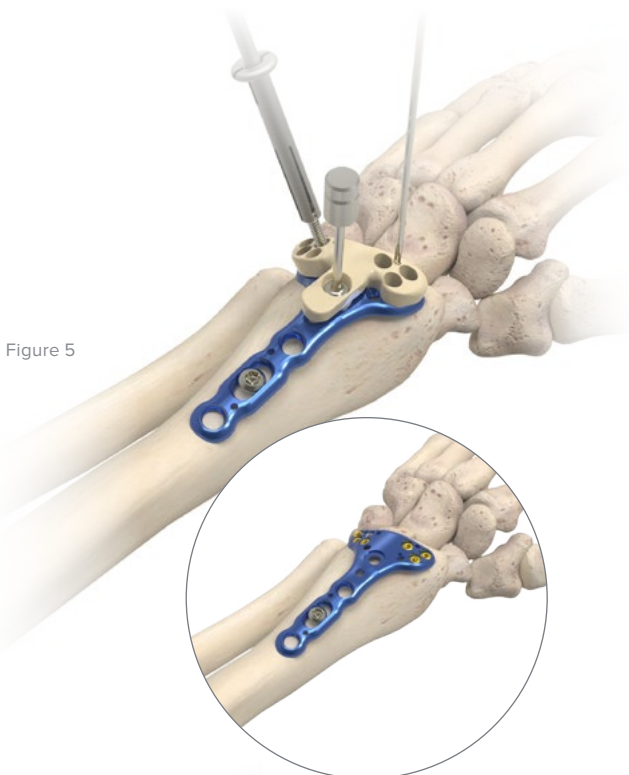

Figure 5

5 Distal Screw Selection and Placement

There are three types of 2.3 mm screws that can be used in any of the eight distal holes: Locking Cortical Screws (gold), Locking Cortical Pegs (bronze), and Nontoggling Cortical Screws (silver). Insert all 2.3 mm screws using the 1.5 mm Hex Driver Tip (HPC-0015), the 2.3 mm Screw Sleeve (MS-SS23), and the Cruciform Driver Handle (MS-2210).

Continue with the placement of the remaining 2.3 mm screws. When finished placing all the distal screws, remove the targeting guide and check to ensure the screws have seated completely in the plate.



Figure 6

6 Proximal Locking Screw Placement

Thread the 3.5 mm Locking Drill Guide (MS-LDG35) into the second proximal locking hole. Drill using the 2.8 mm x 5" Quick Release Drill (MS-DC28) and measure with the 6 mm–70 mm Depth Gauge (MS-9020). Insert the proper length 3.5 mm Locking Cortical Screw (COL-3XX0) using the 2.5 mm Quick Release Hex Driver (HPC-0025), the 3.5 mm Screw Driver Sleeve (MS-SS35), and the Large Cannulated Quick Release Driver Handle (MS-3200). Place the final locking screw using the same process.

Figure 7



Acu-Loc Dorsal Plate Technique [continued]

7 Closure and Postoperative Protocol

Closing and postoperative protocol are at the discretion of the surgeon. The following protocol is provided as an example:

Following thorough radiographic evaluation, close the wound in layers. Repair the retinacula of the second and fourth dorsal compartments. The retinaculum for the third dorsal compartment may be repaired, or the extensor pollicis longus tendon may be left out of its compartment depending on the surgeon's discretion. Initiate postoperatively immediate finger range of motion. Forearm rotation and wrist range of motion are progressed at the surgeon's discretion according to the bone quality, fracture stability, and associated soft-tissue injuries.



Figure 8

8 Optional: Implant Removal Instructions

To extract an Acu-Loc Dorsal Plate, use the 2.5 mm Quick Release Hex Driver (HPC-0025) and Large Cannulated Quick Release Driver Handle (MS-3200) to remove all the 3.5 mm screws in the plate. Use the 1.5 mm Hex Driver Tip and Locking Groove (80-0728) with Cruciform Driver Handle (MS-2210) for the 2.3 mm screws.

Referencing the Screw Removal Brochure (SPF10-00) may aid in implant extraction if difficulty is experienced.



2.5 mm
Quick Release
Hex Driver
(HPC-0025)



Large Cannulated
Quick Release
Driver Handle
(MS-3200)



1.5 mm Hex Driver
Tip and Locking
Groove
(80-0728)



Cruciform Driver
Handle
(MS-2210)

Acu-Loc EX Plate Technique

William B. Geissler, MD

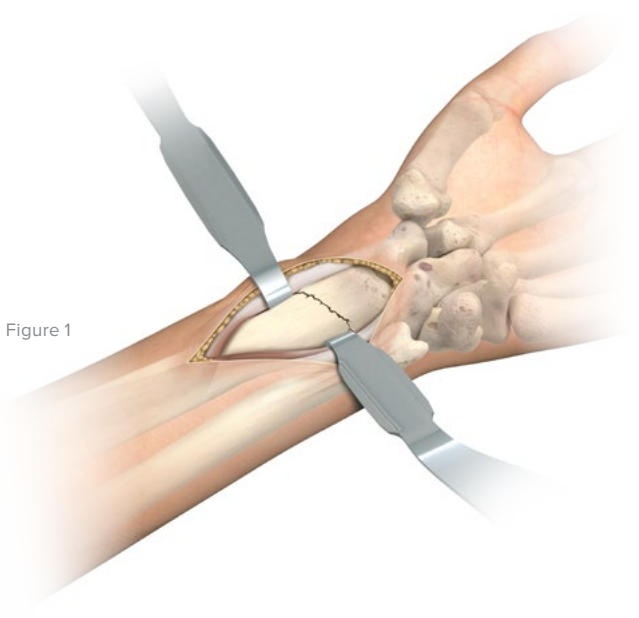

Figure 1

1 Incision and Dissection

Supinate the patient's forearm to expose the surgical site.

To maximize exposure, place a towel under the wrist, placing it in extension. Make a longitudinal incision approximately six centimeters in length just radial to the FCR tendon to protect against potential injury to the palmar cutaneous branch of the median nerve.

Open the tendon sheath and retract the tendon radially to protect the radial artery. Identify the flexor pollicis longus by passive flexion/extension of the thumb interphalangeal joint and retract ulnarly to protect the median nerve. Next identify the pronator quadratus by its transverse fibers and release radially to the ulnar to expose the fracture site.

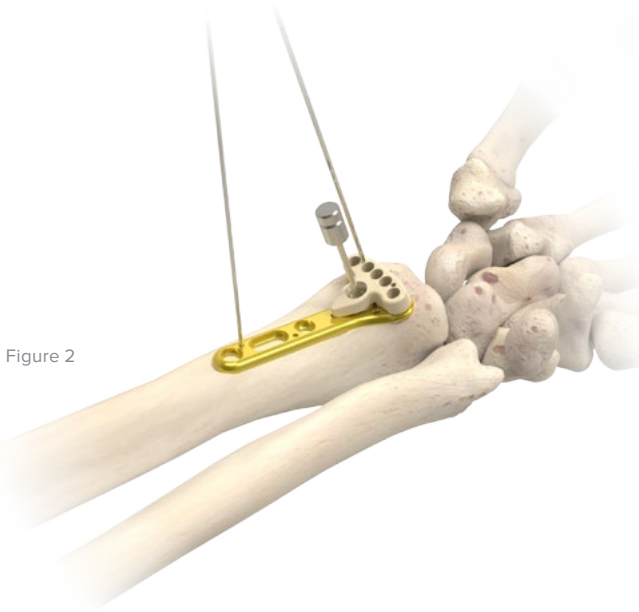

Figure 2

2 Plate Placement and Provisional Fixation

Reduce the fracture and evaluate under fluoroscopy. The brachioradialis may need to be released from its insertion on the radial styloid to facilitate reduction and visualization.

Sit the Acu-Loc EX Plate (70-006X) along the flat metaphyseal portion of the distal radius. The appropriate Acu-Loc EX Targeting Guide (Standard: 80-0166 or Narrow: 80-0274) may be attached to the selected plate using the Locking Screw, Acu-Loc Radiolucent Targeting Guide (80-0038). This may be done on the back table prior to insertion. Then secure the plate's position proximally with a .045" K-wire (WS-1106ST) and distally with a .054" K-wire (WS-1406ST). If the guide is not already attached to the plate, then slide the guide over the distal K-wire and into position. Another method is to secure the plate to the bone with a cortical screw proximally and then attach the targeting guide.



Acu-Loc EX
(70-006X)



Acu-Loc EX
Targeting Guide
(80-0166 or
80-0274)



Locking Screw,
Acu-Loc
Radiolucent
Targeting Guide
(80-0038)



.045" x 6" ST
Guide Wire
(WS-1106ST)
Also used as a K-wire



.054" x 6"
Guide Wire
(WS-1406ST)
Also used as a K-wire

Acu-Loc EX Plate Technique [continued]

3 Nonlocking Proximal Screw Placement

The first nonlocking 3.5 mm Cortical Screw (CO-31X0) is placed through the slot in the plate by first drilling bicortically with the 2.8 mm x 5" Quick Release Drill (MS-DC28) and the Congruent Drill Guide (PL-2018). Measure the drill depth with the 6 mm–70 mm Depth Gauge (MS-9020) and insert the appropriate silver 3.5 mm Cortical Screw, taking care that the screw is the proper length.

Note: Small adjustments to the position of the plate relative to the articular surface can now be done by sliding the plate proximally or distally under fluoroscopy.

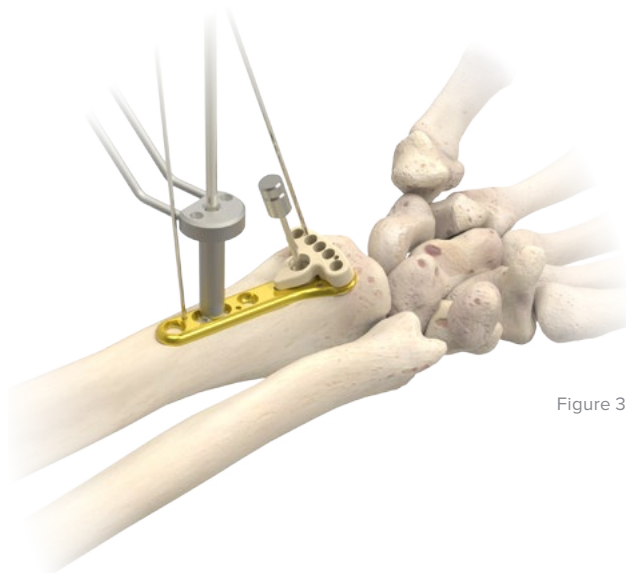

Figure 3

4 Drill Distal Screw Holes

To assess the position of the distal locking screws relative to the articular surface and the dorsum of the radius, a .054" K-wire (WS-1406ST) may be placed through the distal K-wire holes on the Acu-Loc EX Targeting Guide (Standard: 80-0166 or Narrow: 80-0274) and plate. Under fluoroscopy, assess the fracture reduction, the plate position, and the location of the K-wire relative to the joint. If the distal K-wires do not penetrate the joint, the distal 2.3 mm screws will not either. Insert the Drill Guide/Depth Gauge for 2.0 mm Drill (MS-DG23) into one of the five distal holes followed by the 2.0 mm Drill for Distal Radius (MS-DCR20). Measure the depth of the screw using the laser mark on the drill shaft and scale on the drill guide. As an alternative, the Distal Radius Probe (MS-DRPB) may be used by hooking the far cortex and measuring with the laser mark on the probe.

Note: A Drill Guide for Distal Screws (MS-LDG23) is available in the system as an alternative for drilling the distal holes. Screw length can be read using the 6 mm–70 mm Depth Gauge (MS-9020).

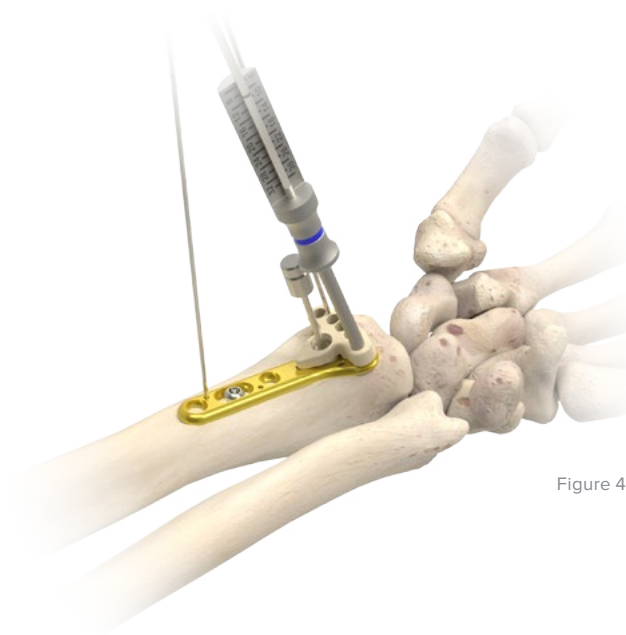
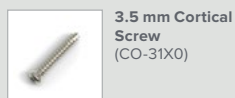

Figure 4



3.5 mm Cortical Screw
(CO-31X0)



2.8 mm x 5" Quick Release Drill
(MS-DC28)



Congruent Drill Guide
(PL-2018)



6 mm–70 mm Depth Gauge
(MS-9020)



.054" x 6" Guide Wire
(WS-1406ST)
Also used as a K-wire



Acu-Loc EX Targeting Guide
(80-0166 or 80-0274)



Drill Guide/Depth Gauge for 2.0 mm Drill
(MS-DG23)



2.0 mm Drill for Distal Radius
(MS-DCR20)



Distal Radius Probe
(MS-DRPB)



Drill Guide for Distal Screws
(MS-LDG23)

Acu-Loc EX Plate Technique [continued]

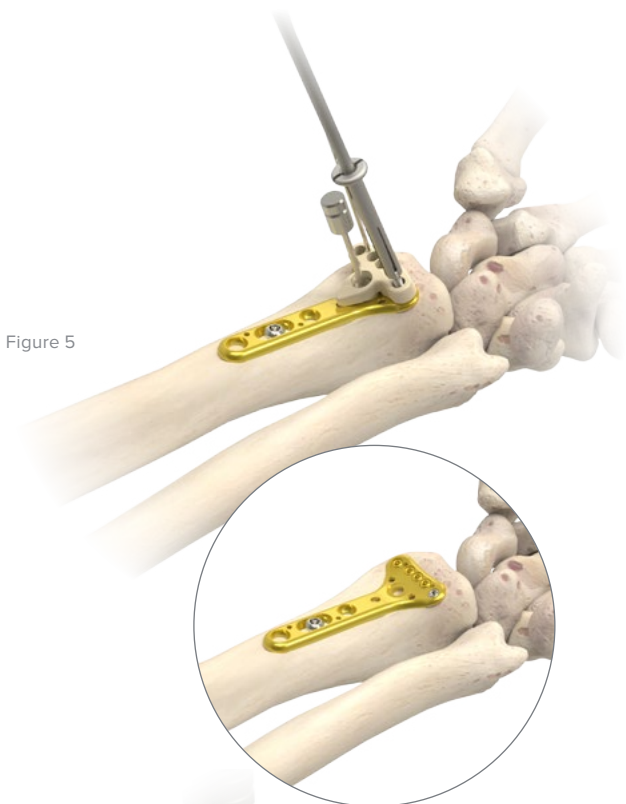

Figure 5



Figure 6

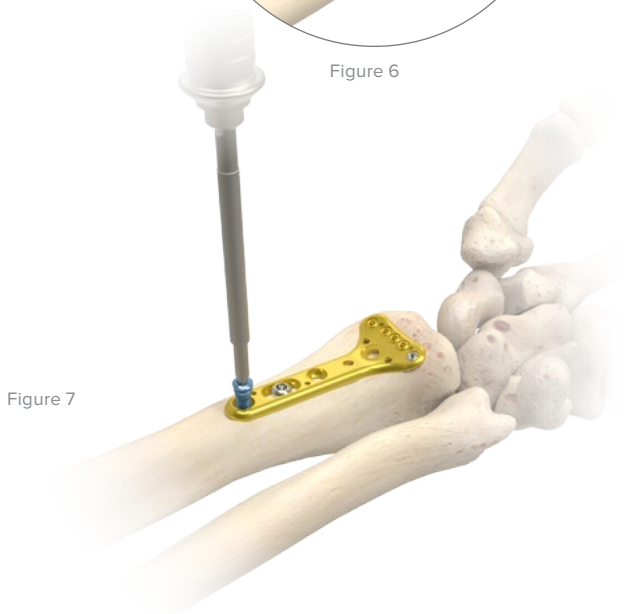

Figure 7

5 Distal Screw Selection and Placement

There are three types of 2.3 mm screws that can be used in any of the five distal holes: Locking Cortical Screws (gold), Locking Cortical Pegs (bronze), and Nontoggling Cortical Screws (silver). Insert all 2.3 mm screws using the 1.5 mm Hex Driver Tip (HPC-0015), the 2.3 mm Screw Sleeve (MS-SS23), and the Cruciform Driver Handle (MS-2210).

6 Proximal Locking Screw Placement

Select one of the two remaining proximal holes and insert the 3.5 mm Locking Drill Guide (MS-LDG35). Drill with the 2.8 mm x 5" Quick Release Drill (MS-DC28) and measure with the 6 mm–70 mm Depth Gauge (MS-9020). Insert the proper length 3.5 mm Locking Cortical Screw (COL-3XX0) using the 2.5 mm Quick Release Hex Driver (HPC-0025), the 3.5 mm Screw Driver Sleeve (MS-SS35), and the Large Cannulated Quick Release Driver Handle (MS-3200), taking care that the screw does not exit the bone dorsally. Using the same process, drill and place the final locking screw.

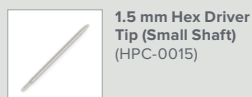

1.5 mm Hex Driver Tip (Small Shaft) (HPC-0015)



2.3 mm Screw Sleeve (MS-SS23)



Cruciform Driver Handle (MS-2210)



3.5 mm Locking Drill Guide (MS-LDG35)



2.8 mm x 5" Quick Release Drill (MS-DC28)



6 mm–70 mm Depth Gauge (MS-9020)



3.5 mm Locking Cortical Screw (COL-3XX0)



2.5 mm Quick Release Hex Driver (HPC-0025)



3.5 mm Screw Driver Sleeve (MS-SS35)



Large Cannulated Quick Release Driver Handle (MS-3200)

Acu-Loc EX Plate Technique [continued]

7 Closure and Postoperative Protocol

Closing and postoperative protocol are at the discretion of the surgeon. The following protocol is provided as an example:

Following thorough radiographic evaluation, check alignment and rotation, then close. Start immediate finger range of motion and forearm rotation post-op. Allow early functional use of the hand for light activities of daily living. Support the wrist according to bone quality and stability.

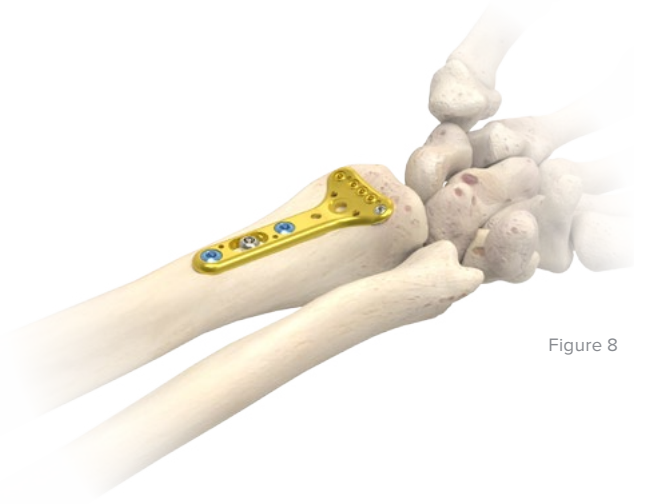

Figure 8

8 Optional: Implant Removal Instructions

To extract an Acu-Loc EX Plate, use the 2.5 mm Quick Release Hex Driver (HPC-0025) and Large Cannulated Quick Release Driver Handle (MS-3200) to remove all the 3.5 mm screws in the plate. Use the 1.5 mm Hex Driver Tip and Locking Groove (80-0728) with Cruciform Driver Handle (MS-2210) for the 2.3 mm screws.

Referencing the Screw Removal Brochure (SPF10-00) may aid in implant extraction if difficulty is experienced.



2.5 mm
Quick Release
Hex Driver
(HPC-0025)



Large Cannulated
Quick Release
Driver Handle
(MS-3200)



1.5 mm Hex Driver
Tip and Locking
Groove
(80-0728)



Cruciform Driver
Handle
(MS-2210)

Acu-Loc VDU Plate Technique

William B. Geissler, MD

1 Incision and Dissection

The Volar Distal Ulna Plate (70-004X) was designed for fractures involving the ulnar head, the ulnar neck, and fractures of the distal ulna. Usually, these injuries are associated with fractures of the distal radius. Make the incision along the distal ulnar border of the forearm between the flexor carpi ulnaris and the extensor carpi ulnaris. Carry down blunt dissection to protect the dorsal sensory branch of the ulnar nerve, which may be seen on the volar distal portion of the incision. Retract the flexor carpi ulnaris radially and dissect the pronator quadratus off the anterior distal surface of the ulna. Identify the fracture site, clear fracture debris, and reduce provisionally.

Figure 1

2 Plate Placement and Provisional Fixation

Place the VDU Plate on the volar surface of the distal ulna so that the four distal locking screws will be positioned to go into the ulnar head. It is vital that the plate is placed just proximal to the lesser sigmoid notch of the distal radial ulnar joint. In this manner, the plate will not impinge with pronation and supination of the forearm.

Place a .045" x 6" K-wire (WS-1106ST) in the proximal portion of the plate. Place a second K-wire in the distal portion of the plate to provisionally hold the plate to the bone.

Figure 2



Acu-Loc Volar Distal Ulna Plate (70-004X)



.045" x 6" ST Guide Wire (WS-1106ST)
Also used as a K-wire

Acu-Loc VDU Plate Technique [continued]

3 Nonlocking Proximal Screw Placement

The first nonlocking 3.5 mm Cortical Screw (CO-31X0) is placed through the slot in the plate by first drilling bicortically with the 2.8 mm x 5" Quick Release Drill (MS-DC28) and the Congruent Drill Guide (PL-2018). Measure the drill depth with the 6 mm–70 mm Depth Gauge (MS-9020) and insert the appropriate silver 3.5 mm Cortical Screw, taking care that the screw is the proper length.

Note: Small adjustments to the position of the plate can now be done by sliding the plate proximally or distally under fluoroscopy.

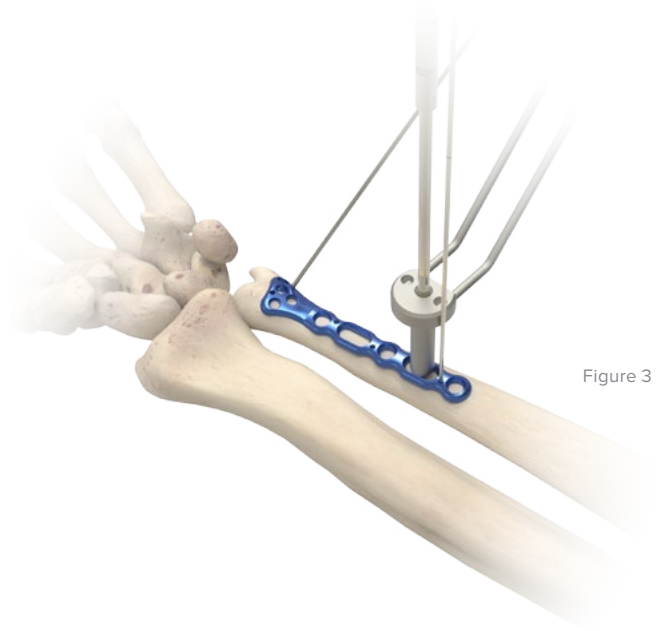

Figure 3

4 Drill Distal Screw Holes

Place the Drill Guide for Distal Screws (MS-LDG23) in the most distal ulnar hole in the plate. Drill using the 2.0 mm Drill for Distal Radius (MS-DCR20) and measure using the 6 mm–70 mm Depth Gauge (MS-9020).

Note: The Locking Drill Guide may also be attached to the selected plate prior to insertion on the back table.

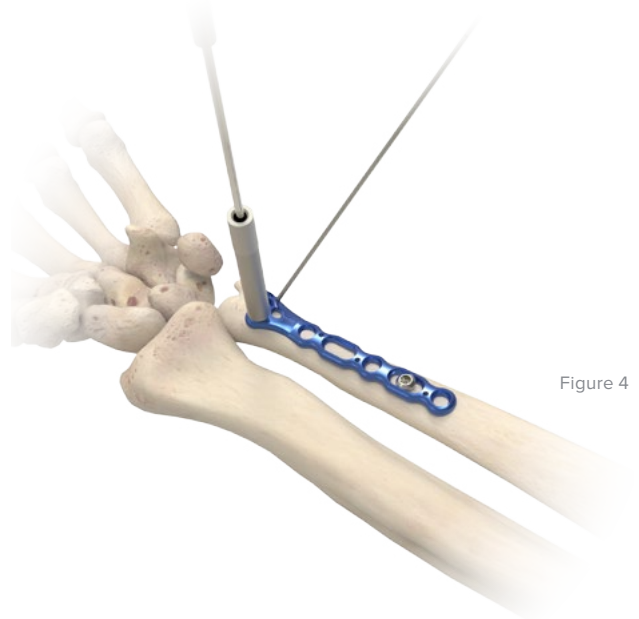
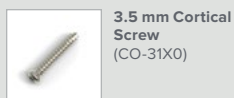

Figure 4



3.5 mm Cortical Screw
(CO-31X0)



2.8 mm x 5" Quick Release Drill
(MS-DC28)



Congruent Drill Guide
(PL-2018)



6 mm–70 mm Depth Gauge
(MS-9020)



Drill Guide for Distal Screws
(MS-LDG23)



2.0 mm Drill for Distal Radius
(MS-DCR20)

Acu-Loc VDU Plate Technique [continued]

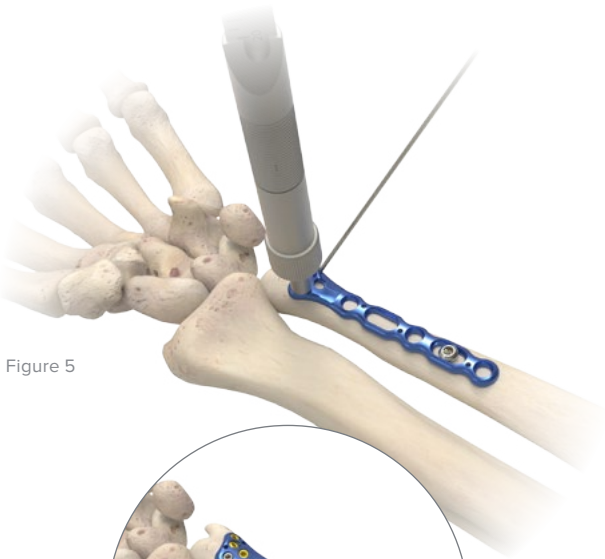

Figure 5



Figure 6

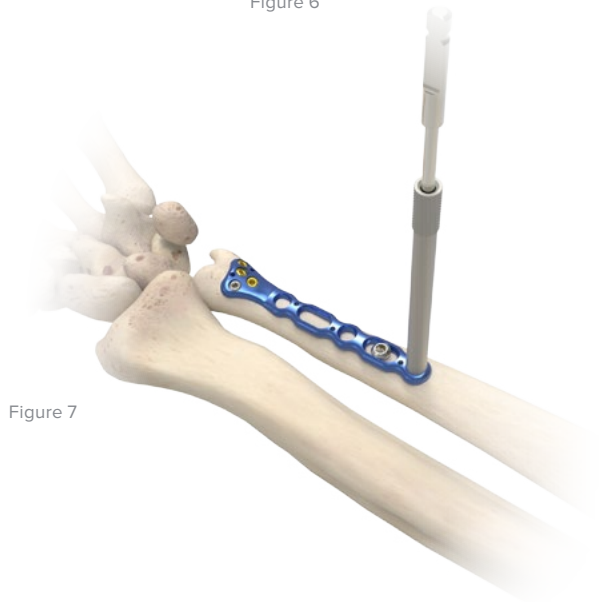

Figure 7

5 Distal Screw Selection

There are three types of 2.3 mm screws that can be used in any of the four distal holes: Locking Cortical Screws (gold), Locking Cortical Pegs (bronze), and Nontoggling Cortical Screws (silver). Insert all 2.3 mm screws using the 1.5 mm Hex Driver Tip (HPC-0015), the 2.3 mm Screw Sleeve (MS-SS23), and the Cruciform Driver Handle (MS-2210).

6 Proximal Locking Screw Placement

Thread the 3.5 mm Locking Drill Guide (MS-LDG35) in the hole just proximal to the slotted hole in the shaft of the plate. Drill with the 2.8 mm x 5" Quick Release Drill (MS-DC28) and measure with the 6 mm–70 mm Depth Gauge (MS-9020). Insert the proper length 3.5 mm Locking Cortical Screw (COL-3XX0) using the 2.5 mm Quick Release Hex Driver (HPC-0025), the 3.5 mm Screw Driver Sleeve (MS-SS35), and the Large Cannulated Quick Release Driver Handle (MS-3200), taking care that the screw does not exit the bone dorsally. Using the same process, drill and place the final locking screw in the remaining locking hole. Remove the proximal K-wire if you have not done so already.

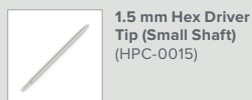

1.5 mm Hex Driver Tip (Small Shaft) (HPC-0015)



2.3 mm Screw Sleeve (MS-SS23)



Cruciform Driver Handle (MS-2210)



3.5 mm Locking Drill Guide (MS-LDG35)



2.8 mm x 5" Quick Release Drill (MS-DC28)



6 mm–70 mm Depth Gauge (MS-9020)



3.5 mm Locking Cortical Screw (COL-3XX0)



2.5 mm Quick Release Hex Driver (HPC-0025)



3.5 mm Screw Driver Sleeve (MS-SS35)



Large Cannulated Quick Release Driver Handle (MS-3200)

Acu-Loc VDU Plate Technique [continued]

7 Closure and Postoperative Protocol

Closing and postoperative protocol are at the discretion of the surgeon. The following protocol is provided as an example:

Following a thorough radiographic evaluation, check alignment and rotation, then close. Start immediate postoperative finger range of motion and forearm rotation. Allow early functional use of the hand for light activities of daily living. Support the wrist according to bone quality and stability.



Figure 8

8 Optional: Implant Removal Instructions

To extract an Acu-Loc VDU Plate, use the 2.5 mm Quick Release Hex Driver (HPC-0025) and Large Cannulated Quick Release Driver Handle (MS-3200) to remove all the 3.5 mm screws in the plate. Use the 1.5 mm Hex Driver Tip and Locking Groove (80-0728) with Cruciform Driver Handle (MS-2210) for the 2.3 mm screws.

Referencing the Screw Removal Brochure (SPF10-00) may aid in implant extraction if difficulty is experienced.



2.5 mm
Quick Release
Hex Driver
(HPC-0025)



Large Cannulated
Quick Release
Driver Handle
(MS-3200)



1.5 mm Hex Driver
Tip and Locking
Groove
(80-0728)



Cruciform Driver
Handle
(MS-2210)

Ordering Information

Tray Components

Instruments

1	Locking Screw, Acu-Loc Radiolucent Targeting Guide	80-0038
2	Distal Radius Probe	MS-DRPB
3	Radiolucent VDR Targeting Guide, Narrow, Left	80-0051
4	Radiolucent VDR Targeting Guide, Narrow, Right	80-0052
5	Radiolucent VDR Targeting Guide, Standard, Left	80-0028
6	Radiolucent VDR Targeting Guide, Standard, Right	80-0029
7	Radiolucent VDR Targeting Guide, Wide, Left	80-0047
8	Radiolucent VDR Targeting Guide, Wide, Right	80-0048

Acu-Loc VDR Plates

9	Acu-Loc VDR Plate, Narrow, Left	PL-DR30L
10	Acu-Loc VDR Plate, Narrow, Right	PL-DR30R
11	Acu-Loc VDR Plate, Standard, Left	PL-DR50L
12	Acu-Loc VDR Plate, Standard, Right	PL-DR50R
13	Acu-Loc VDR Plate, Long, Left	PL-DR60L
14	Acu-Loc VDR Plate, Long, Right	PL-DR60R
15	Acu-Loc VDR Plate, X-Long, Left	PL-DR65L
16	Acu-Loc VDR Plate, X-Long, Right	PL-DR65R
17	Acu-Loc VDR Plate, Wide, Left	PL-DR70L
18	Acu-Loc VDR Plate, Wide, Right	PL-DR70R

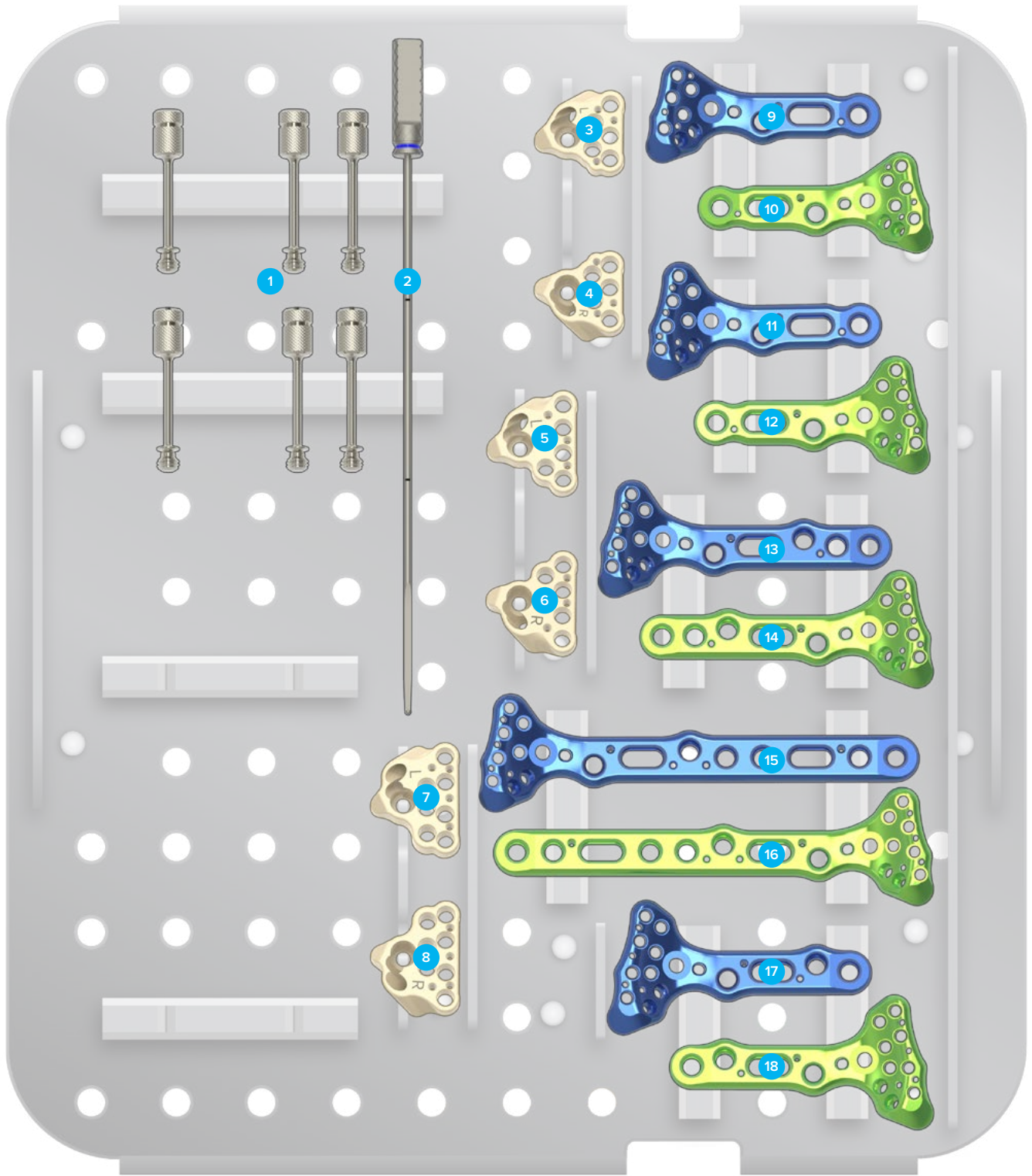

Ordering Information [continued]

Tray Components					
Instruments		Acu-Loc Dorsal Radius Locking Plates			
1	Acu-Loc Dorsal Targeting Guide Standard, Right	80-0151	7	Acu-Loc Dorsal Plate, Standard, Right	70-0056
2	Acu-Loc Dorsal Targeting Guide Standard, Left	80-0150	8	Acu-Loc Dorsal Plate, Standard, Left	70-0055
3	Acu-Loc Dorsal Targeting Guide, Narrow, Right	80-0155	9	Acu-Loc Dorsal Plate, Narrow, Right	70-0058
4	Acu-Loc Dorsal Targeting Guide, Narrow, Left	80-0154	10	Acu-Loc Dorsal Plate, Narrow, Left	70-0057
5	Acu-Loc EX Targeting Guide, Standard	80-0166	Acu-Loc Volar Distal Ulna Plates		
6	Acu-Loc EX Targeting Guide, Narrow	80-0274	11	Acu-Loc VDU Plate, Long, Right	70-0048
			12	Acu-Loc VDU Plate, Long, Left	70-0047
			13	Acu-Loc VDU Plate, Standard, Right	70-0046
			14	Acu-Loc VDU Plate, Standard, Left	70-0045
			Acu-Loc Extra-Articular Plates		
			15	Acu-Loc EX, Standard	70-0063
			16	Acu-Loc EX, Narrow	70-0064

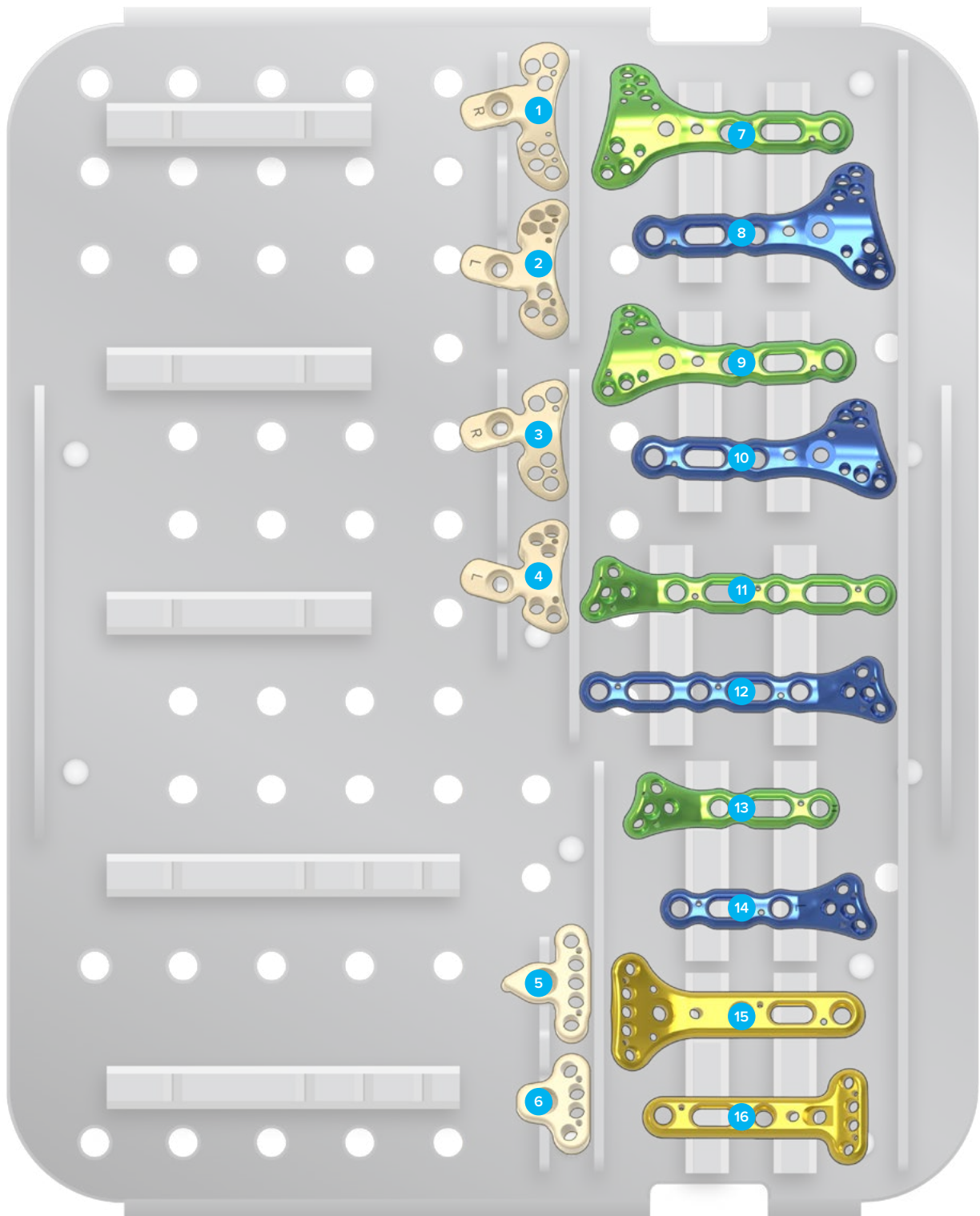

Ordering Information [continued]

Tray Components

Instruments

1	2.5 mm Quick Release Hex Driver	HPC-0025	14	Wire Cutter (.062")	MS-46621
2	3.5 mm Screw Driver Sleeve	MS-SS35	15	Periosteal Elevator	MS-46212
3	3.5 mm Locking Drill Guide	MS-LDG35	16	15 mm Hohmann Retractor	MS-46827
4	6 mm–70 mm Depth Gauge	MS-9020	17	Plate Bender, Large	PL-2045
5	Large Cannulated Quick Release Driver Handle	MS-3200	18	2.0 mm Drill for Distal Radius	MS-DCR20
6	2.8 mm x 5" Quick Release Drill	MS-DC28	19	Drill Guide/Depth Gauge for 2.0 mm Drill	MS-DG23
7	Congruent Drill Guide	PL-2018	20	Cruciform Driver Handle	MS-2210
8	Reduction Forceps With Serrated Jaw	PL-CL04	21	1.5 mm Hex Driver Tip (Small Shaft)	HPC-0015
9	Small Pointed Reduction Forceps	OW-1200	22	Drill Guide for Distal Screws	MS-LDG23
10	Large Screw Holding Forceps	MS-45210	23	2.3 mm Screw Sleeve	MS-SS23
11	Sharp Hook	PL-CL06	24	8" Bone Reduction Forceps	MS-1280
12	.054" x 6" Guide Wire	WS-1406ST			
13	.045" x 6" ST Guide Wire	WS-1106ST			

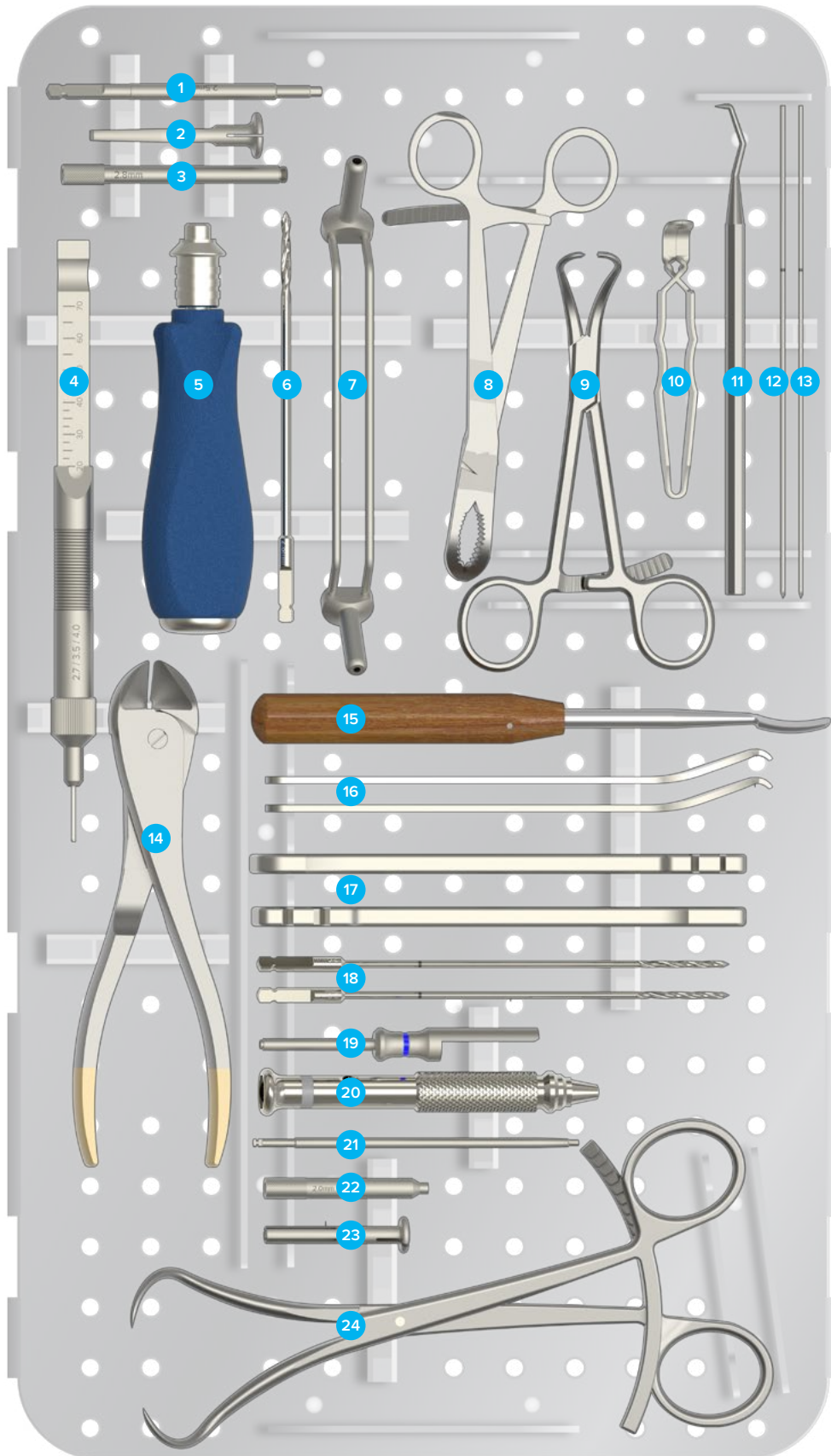

Ordering Information [continued]

Screws			
2.3 mm Locking Cortical Screws		2.3 mm Locking Cortical Pegs	
2.3 mm x 8 mm Locking Cortical Screw	CO-T2308	2.3 mm x 8 mm Locking Cortical Peg	CO-S2308
2.3 mm x 10 mm Locking Cortical Screw	CO-T2310	2.3 mm x 10 mm Locking Cortical Peg	CO-S2310
2.3 mm x 12 mm Locking Cortical Screw	CO-T2312	2.3 mm x 12 mm Locking Cortical Peg	CO-S2312
2.3 mm x 14 mm Locking Cortical Screw	CO-T2314	2.3 mm x 14 mm Locking Cortical Peg	CO-S2314
2.3 mm x 16 mm Locking Cortical Screw	CO-T2316	2.3 mm x 16 mm Locking Cortical Peg	CO-S2316
2.3 mm x 18 mm Locking Cortical Screw	CO-T2318	2.3 mm x 18 mm Locking Cortical Peg	CO-S2318
2.3 mm x 20 mm Locking Cortical Screw	CO-T2320	2.3 mm x 20 mm Locking Cortical Peg	CO-S2320
2.3 mm x 22 mm Locking Cortical Screw	CO-T2322	2.3 mm x 22 mm Locking Cortical Peg	CO-S2322
2.3 mm x 24 mm Locking Cortical Screw	CO-T2324	2.3 mm x 24 mm Locking Cortical Peg	CO-S2324
2.3 mm x 26 mm Locking Cortical Screw	CO-T2326	2.3 mm x 26 mm Locking Cortical Peg	CO-S2326
2.3 mm x 28 mm Locking Cortical Screw	CO-T2328	2.3 mm x 28 mm Locking Cortical Peg	CO-S2328
2.3 mm Nontoggling Cortical Screws		3.5 mm Locking Cortical Screws	
2.3 mm x 8 mm Nontoggling Cortical Screw	CO-N2308	3.5 mm x 8 mm Locking Cortical Screw	COL-3080
2.3 mm x 10 mm Nontoggling Cortical Screw	CO-N2310	3.5 mm x 10 mm Locking Cortical Screw	COL-3100
2.3 mm x 12 mm Nontoggling Cortical Screw	CO-N2312	3.5 mm x 12 mm Locking Cortical Screw	COL-3120
2.3 mm x 14 mm Nontoggling Cortical Screw	CO-N2314	3.5 mm x 14 mm Locking Cortical Screw	COL-3140
2.3 mm x 16 mm Nontoggling Cortical Screw	CO-N2316	3.5 mm x 16 mm Locking Cortical Screw	COL-3160
2.3 mm x 18 mm Nontoggling Cortical Screw	CO-N2318	3.5 mm x 18 mm Locking Cortical Screw	COL-3180
2.3 mm x 20 mm Nontoggling Cortical Screw	CO-N2320	3.5 mm Nonlocking Cortical Screws	
2.3 mm x 22 mm Nontoggling Cortical Screw	CO-N2322	3.5 mm x 10 mm Cortical Screw	CO-3100
2.3 mm x 24 mm Nontoggling Cortical Screw	CO-N2324	3.5 mm x 12 mm Cortical Screw	CO-3120
2.3 mm x 26 mm Nontoggling Cortical Screw	CO-N2326	3.5 mm x 14 mm Cortical Screw	CO-3140
2.3 mm x 28 mm Nontoggling Cortical Screw	CO-N2328	3.5 mm x 16 mm Cortical Screw	CO-3160
2.3 mm x 30 mm Nontoggling Cortical Screw	CO-N2330	3.5 mm x 18 mm Cortical Screw	CO-3180
2.3 mm x 32 mm Nontoggling Cortical Screw	CO-N2332		



Acumed Headquarters
5885 NW Cornelius Pass Road
Hillsboro, OR 97124
Office: +1.888.627.9957
Office: +1.503.627.9957
Fax: +1.503.520.9618
www.acumed.net

These materials contain information about products that may or may not be available in any particular country or may be available under different trademarks in different countries. The products may be approved or cleared by governmental regulatory organizations for sale or use with different indications or restrictions in different countries. Products may not be approved for use in all countries. Nothing contained on these materials should be construed as a promotion or solicitation for any product or for the use of any product in a particular way which is not authorized under the laws and regulations of the country where the reader is located. Specific questions physicians may have about the availability and use of the products described on these materials should be directed to their particular authorized Acumed distributor. Specific questions patients may have about the use of the products described in these materials or the appropriateness for their own conditions should be directed to their own physician.

HNW00-01-F | Effective: 2017/08 | © 2017 Acumed® LLC