

## Surgical Technique



Acumed® is a global leader of innovative orthopaedic and medical solutions.



We are dedicated to developing products, service methods, and approaches that improve patient care.



### Slide-Loc™ Anatomic Radial Head System\*

The Acumed Slide-Loc Anatomic Radial Head System is designed to provide an anatomic implant to replace the patient's native radial head. Designed in conjunction with Shawn W. O'Driscoll, MD, PhD, the Slide-Loc Anatomic Radial Head System utilizes a unique approach to side-loading radial head prostheses, without the use of a set screw. The Slide-Loc Anatomic Radial Head System head and neck assembly slides onto the stem and rotates to lock the components. The Slide-Loc Anatomic Radial Head can be implanted using an *in situ* or *ex situ* (back table assembly) approach. The system is modular and includes several sizes of anatomic heads, three choices of neck heights, and a variety of standard and long stems.

#### Indications for Use:

- ▶ Replacement of the radial head for degenerative or post-traumatic disabilities presenting pain, crepitation, and decreased motion of the radiohumeral and/or proximal radio ulnar joint with: joint destruction and/or subluxation, resistance to conservative treatment.
- ▶ Primary replacement after fracture of the radial head
- ▶ Symptomatic replacement after radial head resection
- ▶ Revision following failed radial head arthroplasty

	Definition
<b>Warning</b>	Indicates critical information about a potential serious outcome to the patient or the user.
<b>Caution</b>	Indicates instructions that must be followed in order to ensure the proper use of the device.
<b>Note</b>	Indicates information requiring special attention.

\*Patent Pending

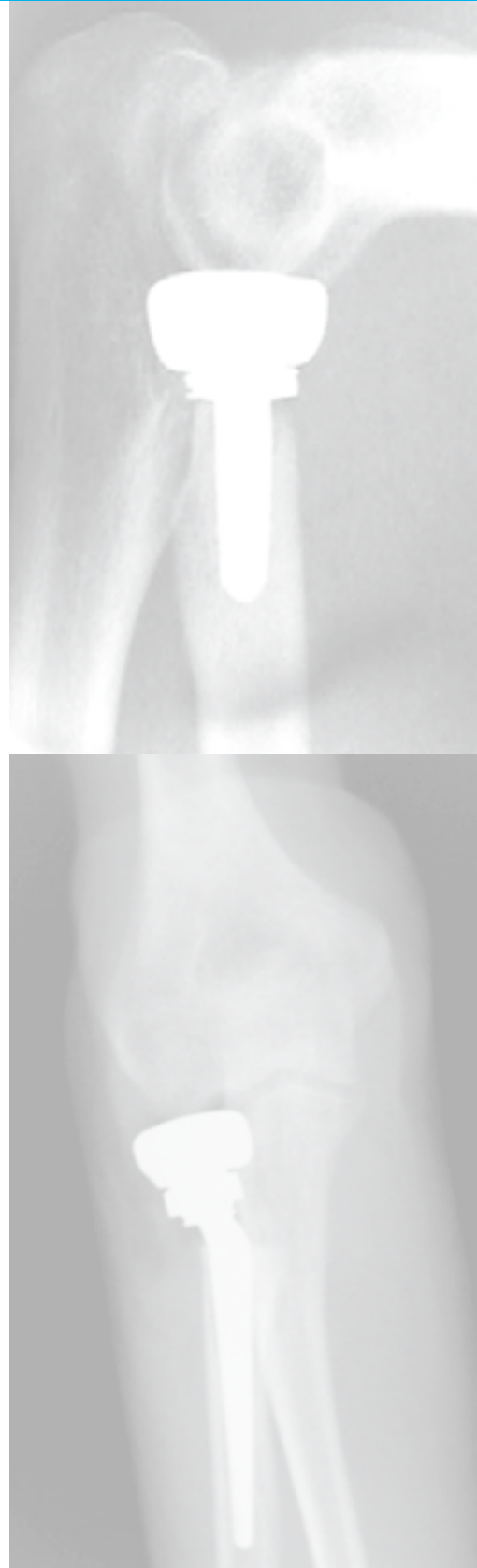

# Table of Contents

System Features .....	<b>2</b>
Instrument Overview .....	<b>6</b>
Component Legend .....	<b>8</b>
Surgical Technique Overview .....	<b>10</b>
Surgical Technique .....	<b>12</b>
Standard Stem <i>In Situ</i> Surgical Technique .....	<b>12</b>
Standard Stem <i>Ex Situ</i> Surgical Technique .....	<b>27</b>
Long Stem Surgical Technique .....	<b>33</b>
Head, Neck, and Stem Removal Surgical Technique .....	<b>45</b>
Ordering Information .....	<b>46</b>

# System Features

## Radial Head Implants

The dish depth varies from 1.8 mm deep (18 mm head) to 3.3 mm deep (28 mm head). Keeping the dish depth proportional to the size of the radial head is intended to improve stability over the current generation Acumed Anatomic Radial Head

The lateral trochlear ridge facet surface has been contoured to optimize contact with the lateral trochlear ridge of the capitellum. Irregular contact in this region may erode the cartilage over time<sup>1,2</sup>



**Head Implants: 18-28 mm**  
(5001-02XXX-S)

1. Sahu D, Holmes DM, Fitzsimmons JS, Thoreson AR, Berglund LJ, An KN, O'Driscoll SW. Influence of radial head prosthesis design on radiocapitellar joint contact mechanics. *J Shoulder Elbow Surg.* 2014;23(4):456-462.

2. Bachman DR, Thaveepunsan S, Park S, Fitzsimmons JS, An KN, O'Driscoll SW. The effect of prosthetic radial head geometry on the distribution and magnitude of radiocapitellar joint contact pressures. *J Hand Surg Am.* 2015;40(2):281-288.

# System Features [continued]

## Neck Implants



## Standard Stem Implants

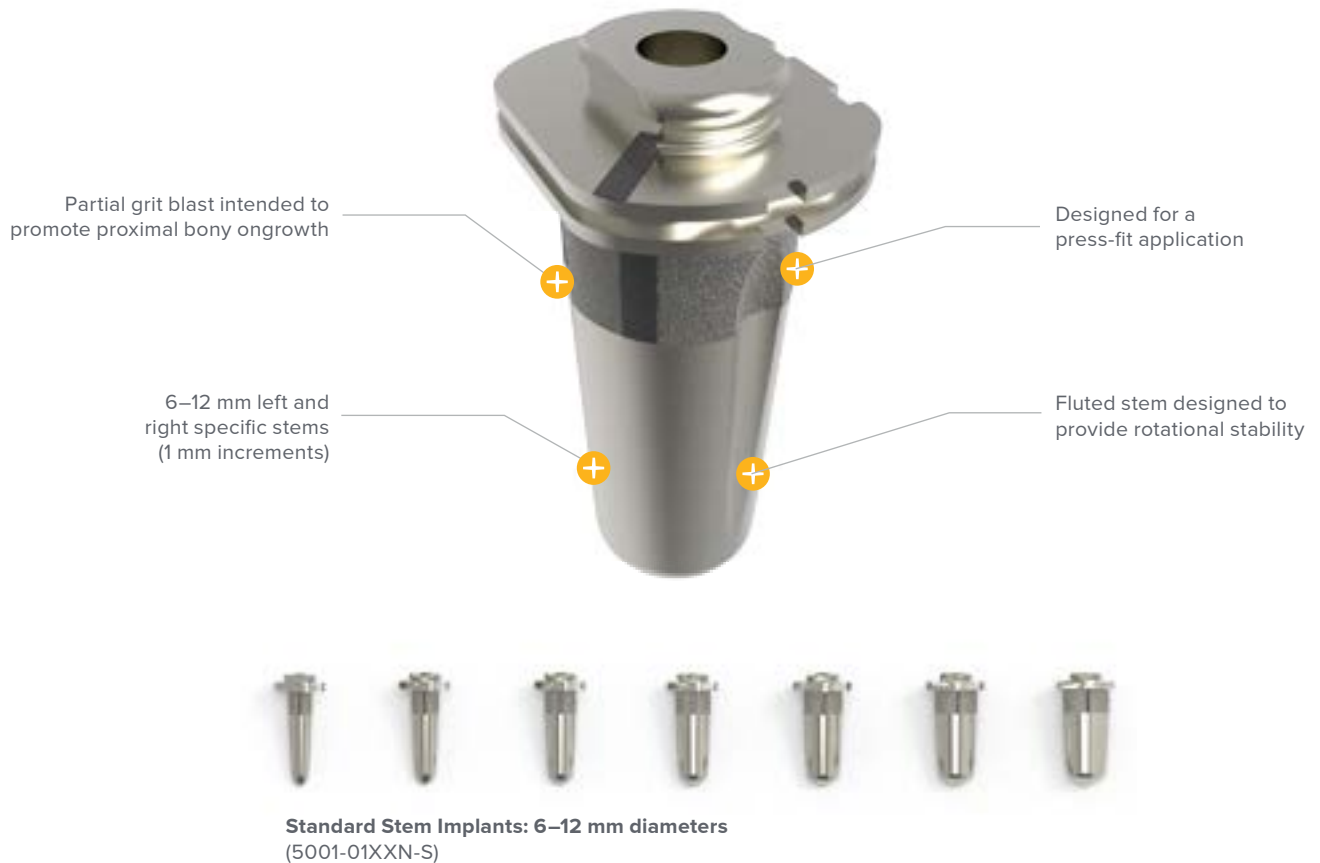

# System Features [continued]

## Long Stem Implants

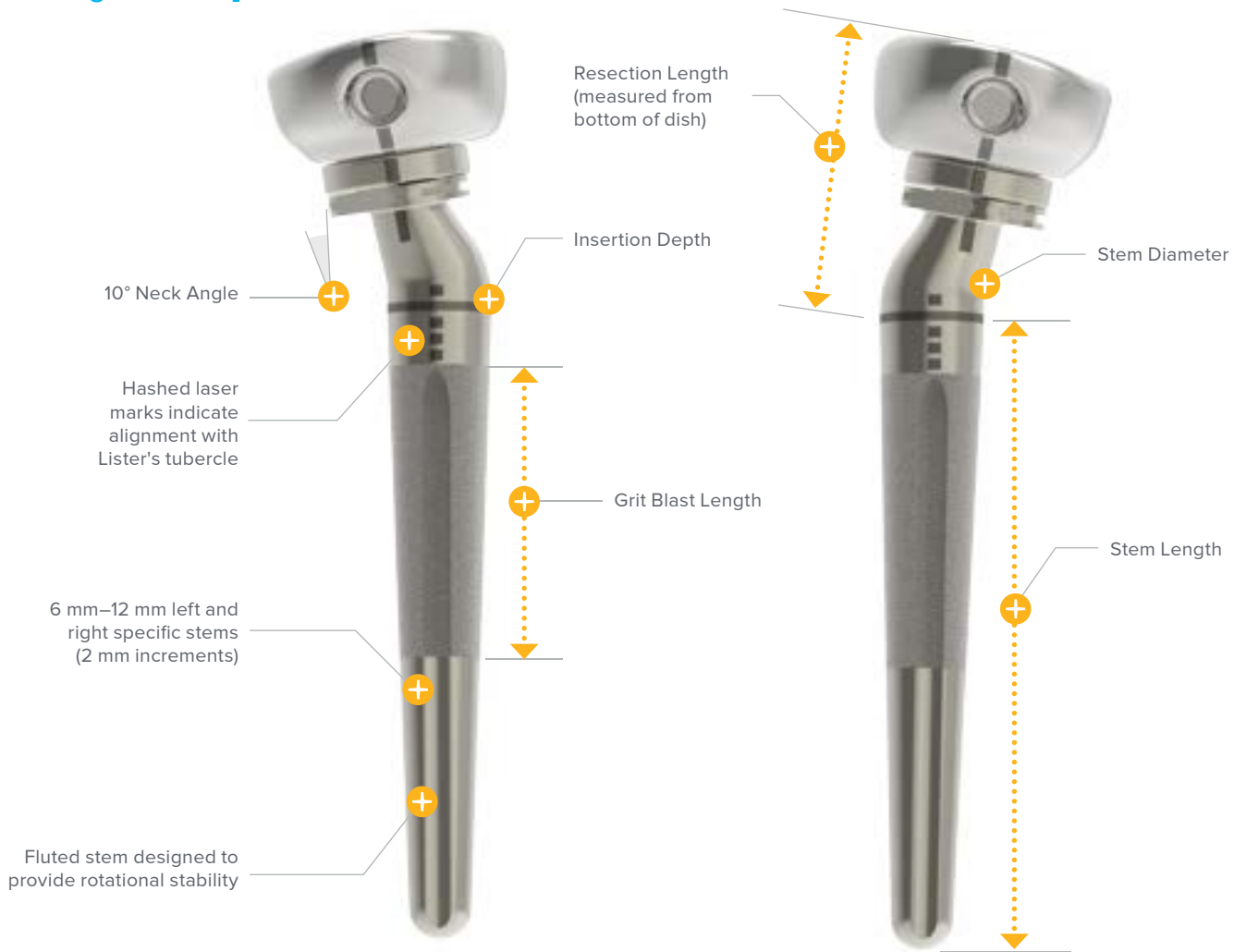

**Long Stem Implants: 6–12 mm diameters**  
(5001-04XXX-S)

Stem Diameter	Resection Length	Stem Length	Grit Blast Length
6 mm	19 mm	50 mm	18 mm
8 mm	22 mm	55 mm	20 mm
10 mm	25 mm	60 mm	22 mm
12 mm	28 mm	65 mm	24 mm

## System Features [continued]

### Head, Neck, and Stem Trials



**ARH Slide-Loc Head Trials: 18–28 mm**  
(5101-02XXX)  
Left trial heads are blue, right trial heads are green



**ARH Slide-Loc Neck Trials**  
(5101-030XN)  
+1 mm, +3 mm, +5 mm options



**ARH Slide-Loc Standard Stem Trials: 6–12 mm (1 mm increments)**  
(5101-01XXN)



**ARH Slide-Loc Long Stem Trials: 6–12 mm (2 mm increments)**  
(5101-04XXX)  
Left trial necks are blue, right trial necks are green

# Instrument Overview



**Standard Stem Reamer 6 mm**  
(80-1606)



**Standard Stem Reamer 7 mm**  
(80-1607)



**Standard Stem Reamer 8 mm**  
(80-1608)



**Standard Stem Reamer 9 mm**  
(80-1609)



**Standard Stem Reamer 10 mm**  
(80-1610)



**Standard Stem Reamer 11 mm**  
(80-1611)



**Standard Stem Reamer 12 mm**  
(80-1612)



**Long Stem Reamer 6 mm**  
(80-1706)



**Long Stem Reamer 8 mm**  
(80-1708)



**Long Stem Reamer 10 mm**  
(80-1710)



**Long Stem Reamer 12 mm**  
(80-1712)



**6 mm Collar Reamer**  
(TR-CRA06)



**7 mm Collar Reamer**  
(TR-CRA07)



**8 mm Collar Reamer**  
(TR-CRA08)



**9 mm Collar Reamer**  
(TR-CRA09)



**10 mm Collar Reamer**  
(TR-CRA10)



**11 mm Collar Reamer**  
(TR-CRA11)



**12 mm Collar Reamer**  
(TR-CRA12)



**Bone Graft Ratcheting T-Handle**  
(BG-8043)



**Quick Release T-Handle**  
(MS-T1212)



## Instrument Overview [continued]

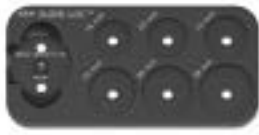

**ARH Slide-Loc Impactor Block**  
(80-1503)



**ARH Slide-Loc Head Assembly Tool**  
(80-1511)



**Head Impactor**  
(TR-MS05)



**ARH Slide-Loc Stem Clamp**  
(80-2538)



**ARH Slide-Loc Trial Head Handle**  
(80-2004)



**Cross Bar**  
(80-1771)



**ARH Slide-Loc Height Gauge +1 mm**  
(80-1581)



**ARH Slide-Loc Stem Inserter**  
(80-1357)



**ARH Slide-Loc Height Gauge +3 mm**  
(80-1583)



**5.5 mm Quick Release Awl**  
(TR-0206)



**ARH Slide-Loc Height Gauge +5 mm**  
(80-1585)



**ARH Slide-Loc Locking Guide +1 mm**  
(80-2542)



**Long Stem Resection Guide**  
(80-1512)



**ARH Slide-Loc Locking Guide +3 mm**  
(80-2543)



**Radius Retractor**  
(80-1509)



**ARH Slide-Loc Locking Guide +5 mm**  
(80-2544)

# Component Legend

## Trial Neck

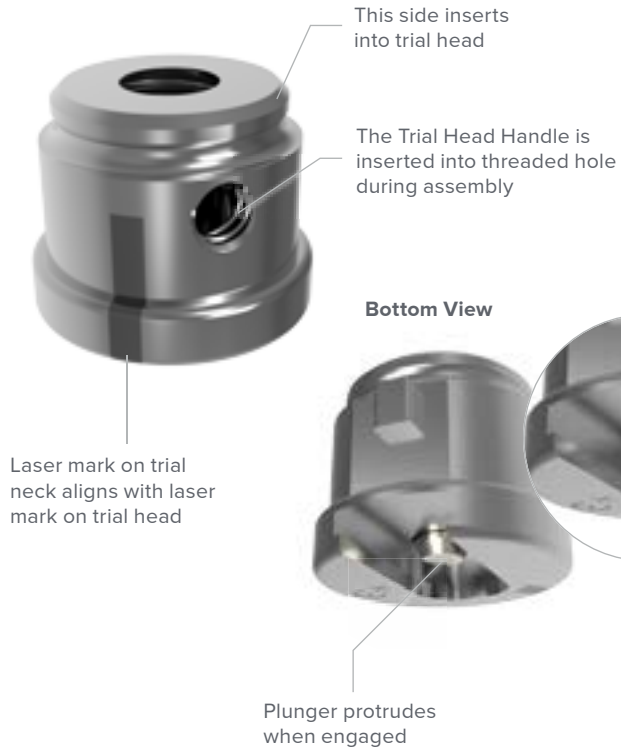

## Implant Neck



## Stems



## Component Legend [continued]

### ARH Slide-Loc Stem Clamp

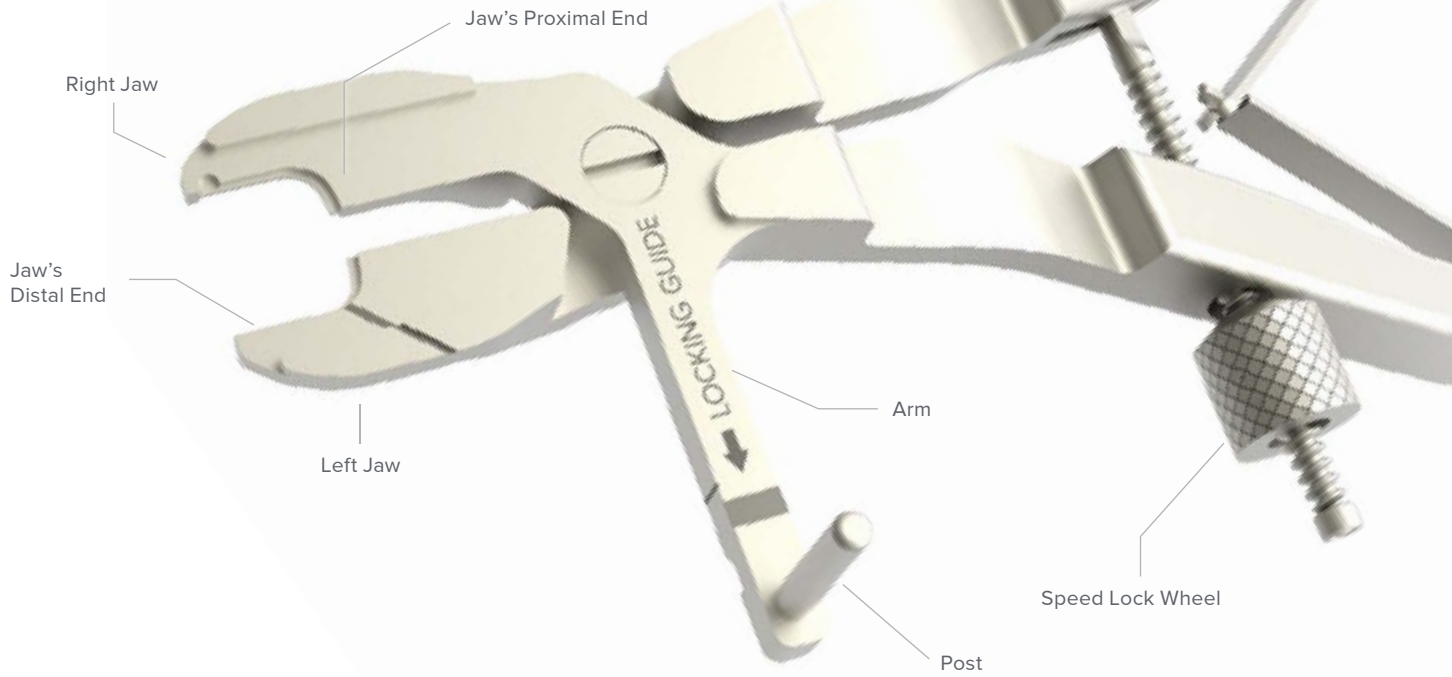

### ARH Slide-Loc Locking Guide



# Surgical Technique Overview

## Standard Stem In Situ Surgical Technique

## Standard Stem Ex Situ Surgical Technique

Resection



Reaming



Determine  
Diameter



Trial Assembly & Insertion

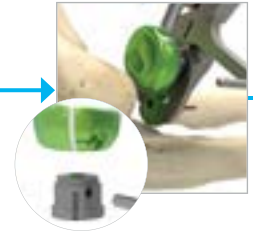

Trial Assembly & Insertion



Resection



Reaming



Secondary Resection  
and Reaming



Determine Diameter



## Long Stem Surgical Technique

Head/Neck Removal



Stem Removal



## Head, Neck, and Stem Removal

Implant Assembly



Implant Insertion



Postoperative Protocol

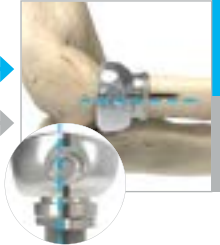

Implant Assembly



Implant Insertion



Trial Assembly & Insertion

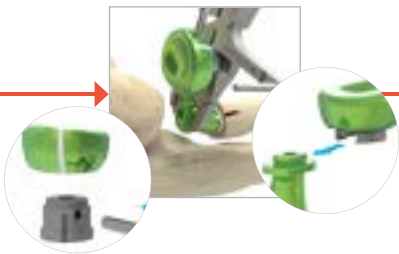

Implant Assembly



Implant Insertion



Postoperative Protocol



# Standard Stem *In Situ* Surgical Technique

## Part One: Site Preparation and Trialing

**Warning:** Use of a posterior approach may interfere with *in situ* assembly of the implant.

Figure 1

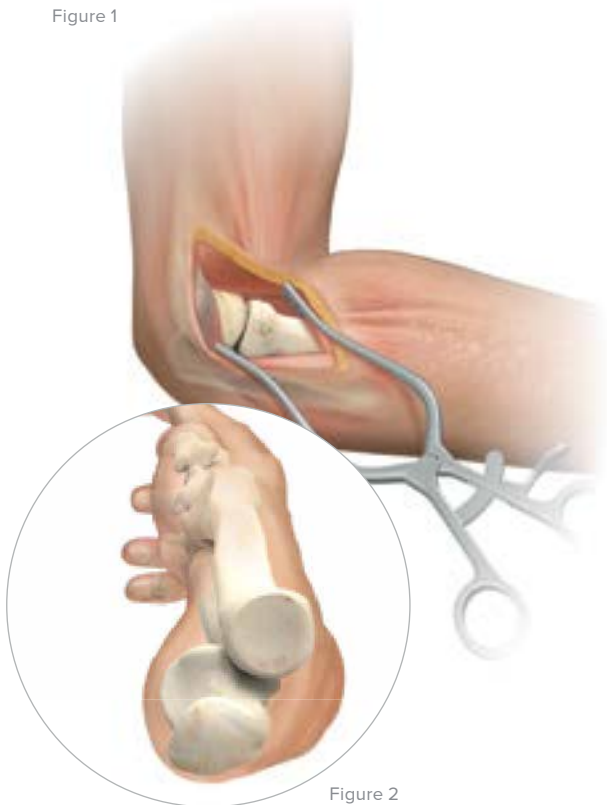

Figure 2

### 1 Incision and Dissection

A hybrid approach may be used to preserve the lateral ulnar collateral ligament (LUCL) and facilitate exposure of the radial head and anterior joint. An incision is made along a line connecting the lateral epicondyle and the equator of the radial head. Proximal dissection is carried along the lateral column of the distal humerus. Distal dissection is carried longitudinally along the radial shaft.

In fracture dislocations, the exposure is through the traumatic opening in the ligament complex. For delayed reconstructions, a Kocher approach is often necessary to adequately subluxate the radius for instrumentation and prosthetic implantation. The Kaplan interval permits the ligament to be left intact. With either approach, the deep incision is placed in a line from the lateral epicondyle toward Lister's tubercle, with the forearm in neutral rotation. Proximally, the extensor longus (ECRL) origin is released with the anterior capsule to permit direct access to the front of the radial head.

With any of these approaches, deep dissection is performed with the forearm in pronation to maximize the distance from the posterior interosseous nerve (PIN). In pronation, the PIN crosses the midpoint of the radial shaft an average of 5.6 cm distal to the capitellum.<sup>1</sup> Furthermore, the PIN has been demonstrated to be within the substance of the supinator muscle 98% of the time.<sup>2</sup> Therefore, common to all exposures, deep dissection includes division of the annular ligament and subsequent exposure of the proximal radial neck. More distal dissection is easily achieved with subperiosteal elevation of the overlying supinator while the forearm is pronated. This method minimizes the potential for structural injury to the PIN.

1. Calfee RP, Wilson JM, Wong AH. Variations in the anatomic relations of the posterior interosseous nerve associated with proximal forearm trauma. *J Bone Joint Surg Am.* 2011;93(1):81-90.
2. Tornetta P, Hochwald N, Bono C, Grossman M. Anatomy of the posterior interosseous nerve in relation to fixation of the radial head. *Clin Orthop Relat Res.* 1997;345:215-218.

## Standard Stem *In Situ* Surgical Technique [continued]

### 2 Radial Head Resection

Using a microsagittal saw, resect the radial head at the level of the fracture without leaving a significant neck defect. The standard stems can replace 12 mm to 16 mm of resection. The length is measured from the bottom of the radial head's dish.

Resection Length	Neck size
12 mm	+1
14 mm	+3
16 mm	+5

If greater than 16 mm of resection is needed, ARH Slide-Loc Long Stems are available (see page 33 for surgical technique).

Figure 3



### 3 Determine Stem Diameter

Use the 5.5 mm Quick Release Awl (TR-0206) to initially enter the canal. Then assemble the Bone Graft Ratcheting T-Handle (BG-8043) to the Standard Stem Reamer 6 mm (80-1606) and prepare the canal for the stem using sequentially larger reamers (80-1607 through 80-1612) until “cortical chatter” and a tight fit are achieved. The proper reaming depth is achieved when the laser mark band on the reamer is flush with the level of resection. A Radius Retractor (80-1509) is available to elevate the radius.

**Note:** Confirm the fit by rotating the reamer inside the forearm. If the forearm rotates when the reamer is turned, a sufficiently tight fit has been achieved.

**Warning:** The Standard Stem Reamers (80-16XX) are not intended to be used under power. Using the reamers under power may result in fracturing the radial canal.

Figure 4



5.5 mm Quick Release Awl (TR-0206)



Bone Graft Ratcheting T-Handle (BG-8043)



Radius Retractor (80-1509)



Standard Stem Reamer (80-16XX)

## Standard Stem *In Situ* Surgical Technique [continued]

Figure 5



### 4 Ream With Collar Reamer

Select the Collar Reamer (TR-CRAXX) that matches the stem diameter determined by the reamer in the previous step. Power ream the collar to create a surface with at least 60% of the radial shaft in contact with the reamer. Use caution to avoid fracturing the radial neck, which can occur if the reamer catches on irregular bone in the fracture surface. The risk of such fracturing can be lessened by reaming initially in the reverse direction, such that the reamer acts more as a power rasp. If there is concern about risk of fracture (eg if a notch exists), a provisional cerclage wire may be placed around the neck and removed after inserting the prosthesis.

Figure 6



### 5 Determine Head Diameter

Determine the head diameter by placing the resected head upside down in the sizing pockets on the ARH Slide-Loc Impactor Block (80-1503). If between sizes or if the head fits loosely in the sizing pocket, select one size smaller.



Collar Reamer  
(TR-CRAXX)



ARH Slide-Loc  
Impactor Block  
(80-1503)



## Standard Stem *In Situ* Surgical Technique [continued]

### 6 Determine Neck Height

Determining the appropriate neck height is critical to restoring the joint space. It must be done with the ulnohumeral joint reduced, which can best be performed by compressing the olecranon against the distal humerus with the elbow flexed 90 degrees. It is critical that the coronoid contacts the trochlea during this process. The technique involves not only confirming the correct length, but also confirming that a shorter length is too short and a longer length is too long.

Insert the ARH Slide-Loc Height Gauge +1 mm (80-1581) and determine if the gauge simultaneously contacts the resected radius and capitellum. If there is no contact, sequentially insert a taller height gauge until it contacts the radius and the capitellum.

The number on the height gauge (+1 mm, +3 mm, +5 mm) will correspond to the neck height component. Confirm that the next longer length is too long by inserting the next length gauge and confirming that it is too tight or by observing that the radius is displaced distally or the coronoid is separated from the trochlea.

**Warning:** If between sizes, select the shorter neck height. Implantation of components that are too large may result in a joint that is "overstuffed."



Figure 7



ARH Slide-Loc  
Height Gauge  
(80-15XX)

## Standard Stem *In Situ* Surgical Technique [continued]

Figure 8

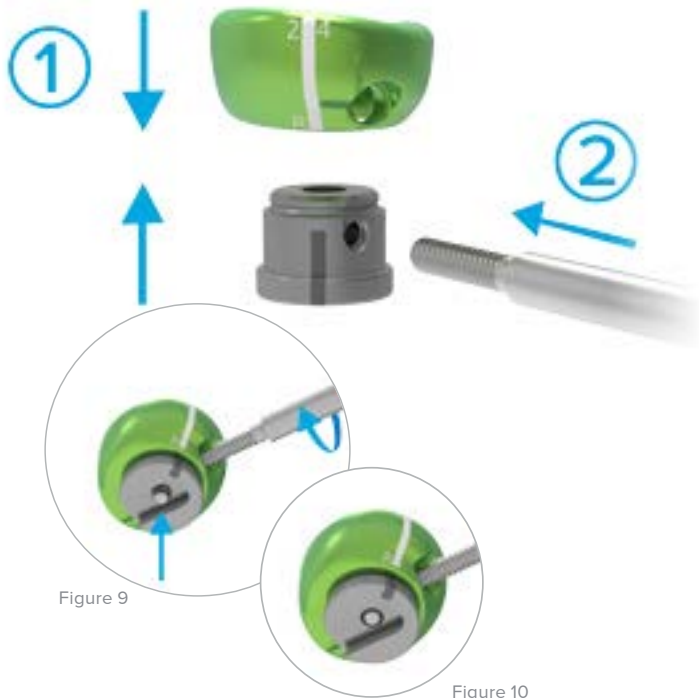

### 7 Select Trial Implants and Assemble

After selecting the ARH Slide-Loc Trial Head (5101-02XXX) and ARH Slide-Loc Trial Neck (5101-03XXN), align the laser marks on the head and neck as shown and assemble using hand pressure. Attach the ARH Slide-Loc Trial Head Handle (80-2004) to the assembled trial head/neck (Figure 9). The trial head handle retracts the plunger in the trial neck (Figure 10).

**Note:** Left-specific trials are blue and right-specific trials are green.

**Caution:** Ensure that the plunger is completely retracted by inserting the trial head handle into the trial neck until fully seated. A partially retracted plunger may prevent the trial neck from sliding onto the trial stem.

**Warning:** Do not install the trial head/neck assembly onto the **implant** stem for the purpose of assessing or evaluating the components. Trialing requires the removal of the stem clamp, and reattaching it to the implant stem *in situ* is difficult. Improperly securing the clamp to the implant stem can result in incomplete locking of the head/neck to the stem and may result in disengagement of the components postoperatively.

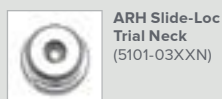
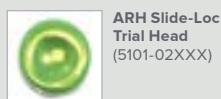

## Standard Stem *In Situ* Surgical Technique [continued]

### 8 Insert Trial Stem

Rotate the forearm to a neutral position. Mark the lateral aspect of the radial neck with the cautery, in line with Lister's tubercle.

The steps below can help ensure the clamp is secured to the trial stem (refer to Component Legend on pages 8 and 9 for component references):

1. Hold the body of the ARH Slide-Loc Trial Standard Stem (5101-01XXN) with the thumb and index finger.
2. Attach the ARH Slide-Loc Stem Clamp (80-2538) to the stem by first aligning the stem's laser mark with the clamp's laser mark.
3. Place the clamp's left jaw into the stem's left groove.
4. Squeeze the clamp's handles until the right jaw engages the stem's right groove (side with two notches).
5. Verify no gaps exist between the stem's grooves and the clamp's jaws. If a gap exists, wiggle the stem's body until the jaws are fully seated in the grooves.
6. Tighten the clamp's speed lock wheel firmly to engage the connection between the clamp and the stem.
7. Completely thread the ARH Slide-Loc Stem Inserter (80-1357) into the stem.

Insert the ARH Slide-Loc Trial Standard Stem into the radius with the laser mark on the stem aligned with the cautery marking on the lateral aspect of the radius. The stem inserter should be used to aid in stem insertion. Insert the trial stem until its base or platform is flush with the canal's surface or cut. The standard stem trials are .25 mm undersized from the reamers for ease of insertion.

**Caution:** If it is necessary to use a mallet, hit the stem inserter on the handle, but do not hit the stem clamp. This will ensure that the connection between the trial stem and clamp is preserved and prevents damage to the stem clamp (Figure 11).

Figure 11



ARH Slide-Loc Trial Standard Stem  
(5101-01XXN)



ARH Slide-Loc Stem Clamp  
(80-2538)



ARH Slide-Loc Stem Inserter  
(80-1357)

## Standard Stem *In Situ* Surgical Technique [continued]

Figure 12

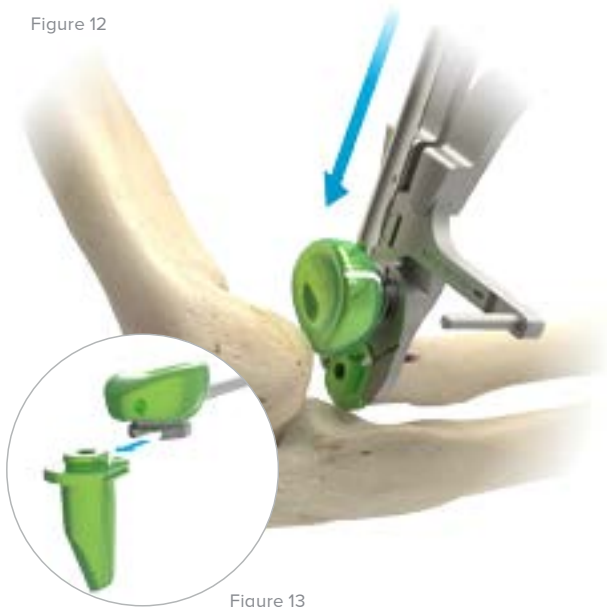

### 9 Attach Trial Head/Neck to Trial Stem

1. Position the ARH Slide-Loc Trial Head Handle (80-2004) so the shaft is parallel with the jaws of the ARH Slide-Loc Stem Clamp (80-2538) (Figure 14). This reduces the likelihood of the trial neck sliding off axis on the trial stem and the trial neck's plunger not engaging with the trial stem's base. While slightly retracting the radius with the ARH Slide-Loc Stem Clamp, slide the trial head/neck assembly completely onto the trial stem's rails.
2. Unthread the trial head handle to engage the trial neck's plunger in the trial stem for provisional fixation. While unthreading the trial head handle from the trial head/neck assembly, apply axial (downward) pressure on the trial stem. This helps ensure it remains fully seated and the trial neck's plunger properly engages the trial stem.

Figure 13



Figure 14

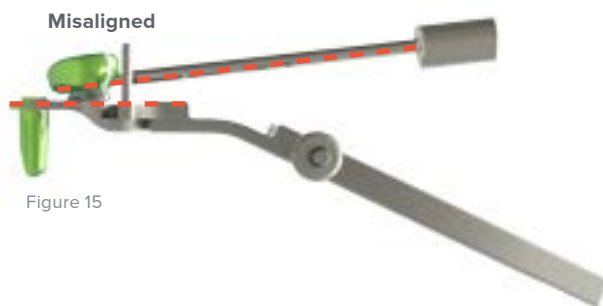

Figure 15



ARH Slide-Loc  
Trial Head Handle  
(80-2004)



ARH Slide-Loc  
Stem Clamp  
(80-2538)

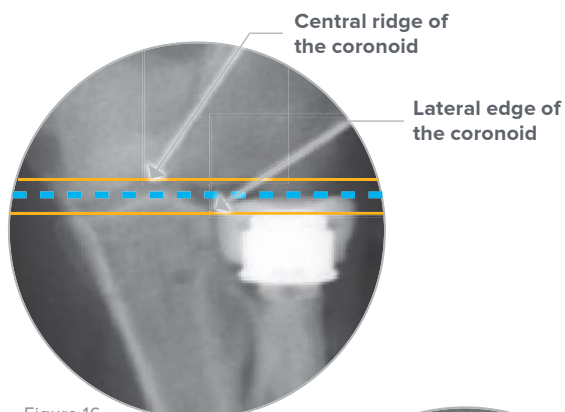

Figure 16

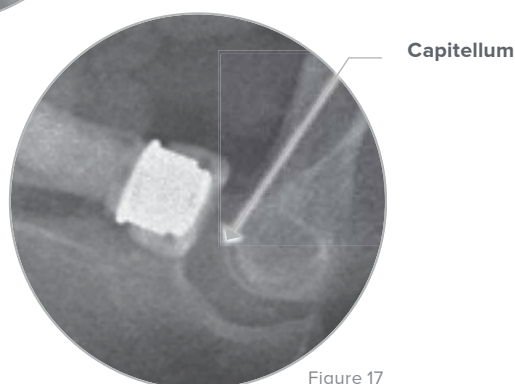

Figure 17

3. Proceed in determining if the trials are the appropriate sizes. Consider using the contralateral X-ray as a reference point.
  - ▶ Check for proper articulation with the capitellum and the coronoid (figures 16 and 17). The line along the articular margin of the radial head (blue line) should fall between parallel lines that pass through the central ridge and lateral edge of the coronoid (gold lines).<sup>3</sup>
4. Once the trial components have been assessed, remove the trial head/neck assembly by attaching the trial head handle and sliding the components off the trial stem's rails. Then remove the trial stem.

**Note:** Forceps or Kochers may be used to remove the standard trial stem. If desired, the ARH Slide-Loc Stem Inserter (80-1357) is available to aid with the trial stem's removal.

**Caution:** DO NOT rotate the trial head/neck assembly (Figure 18). Doing so **will damage** the trial head, neck, and handle to the point that the components are unusable.

**Warning:** Trial components are NOT designed to be implanted.

3. Doornberg JN, Linzel DS, Zurakowski D, Ring D. Reference points for radial head prosthesis size. *J Hand Surg Am.* 2006;31(1):53-57.



Figure 18



ARH Slide-Loc  
Stem Inserter  
(80-1357)

## Standard Stem *In Situ* Surgical Technique [continued]

### Part Two: Implantation

# 10A Assemble the Implant Head and Neck

Verify the Morse taper interface between the head and neck is clean and dry.

1. Insert the selected ARH Slide-Loc Neck (5001-030XN-S) into the ARH Slide-Loc Head (5001-02XXX-S) with the laser marks on both components aligned.
2. Apply slight pressure to the head/neck assembly while keeping the laser marks aligned to initiate the connection.
3. Place the head and neck on the ARH Slide-Loc Impactor Block (80-1503).
4. Lock the Morse taper using the Head Impactor (TR-MS05) and a mallet. Apply multiple high impact strikes to firmly engage the Morse taper connection.
5. Remove the head/neck assembly.
6. Once the implant head and neck are fully engaged, attach the ARH Slide-Loc Head Assembly Tool (80-1511) to the implant head.

**Note:** To help align the fine threads between the Head Assembly Tool and Implant Head, hold the shaft of the ARH Slide-Loc Head Assembly Tool while turning it clockwise (Figure 21).

**Caution:** The head/neck assembly should be done on a firm surface (ie, avoid using a Mayo stand) to ensure that adequate force is applied to the Morse taper connection.

**Warning:** Incomplete mating of the head and neck may result in disengagement of the components postoperatively.



Figure 19



Figure 20

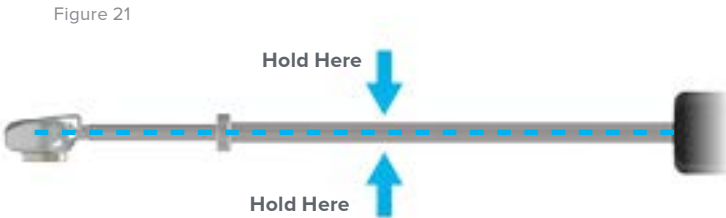

Figure 21



ARH Slide-Loc Neck (5001-030XN-S)



ARH Slide-Loc Head (5001-02XXX-S)



ARH Slide-Loc Impactor Block (80-1503)



Head Impactor (TR-MS05)



Head Assembly Tool (80-1511)

# 10B Prepare Stem for Implantation

**Warning:** Properly securing the implant stem to the clamp is critical to ensuring the implant stem remains in a fixed or stable position when the implant head/neck assembly is rotated and locked.

Follow the steps below to ensure that the clamp is secured to the stem:

1. Hold the body of the ARH Slide-Loc Standard Stem (5001-01XXN-S) with the thumb and index finger.
2. Attach the ARH Slide-Loc Stem Clamp (80-2538) to the stem by first aligning the stem's laser mark with the clamp's laser mark.
3. Place the clamp's left jaw into the stem's left groove (Figure 23).
4. Squeeze the clamp's handles until the right jaw engages the stem's right groove (side with two notches) (Figure 24).
5. Verify no gaps exist between the stem's grooves and the clamp's jaws. If a gap exists, wiggle the stem's body until the jaws are fully seated in the grooves.
6. Tighten the clamp's speed lock wheel firmly to engage the connection between the clamp and the stem.
7. Thread the ARH Slide-Loc Stem Inserter (80-1357) into the stem.

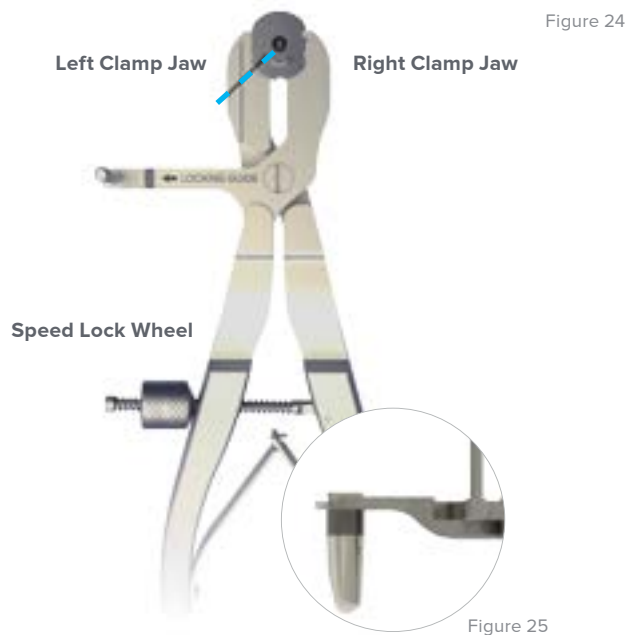
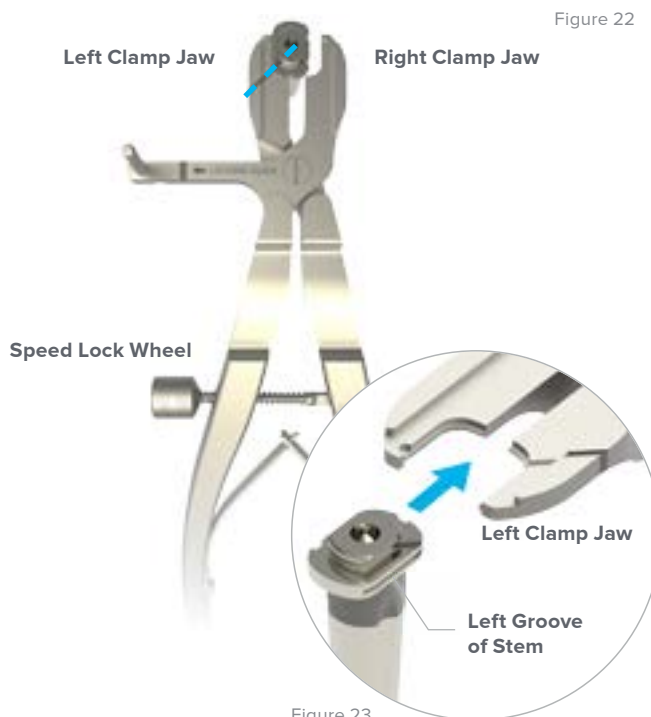

ARH Slide-Loc Standard Stem (5001-01XXN-S)



ARH Slide-Loc Stem Clamp (80-2538)



ARH Slide-Loc Stem Inserter (80-1357)

## Standard Stem *In Situ* Surgical Technique [continued]

Figure 26

Hit Here

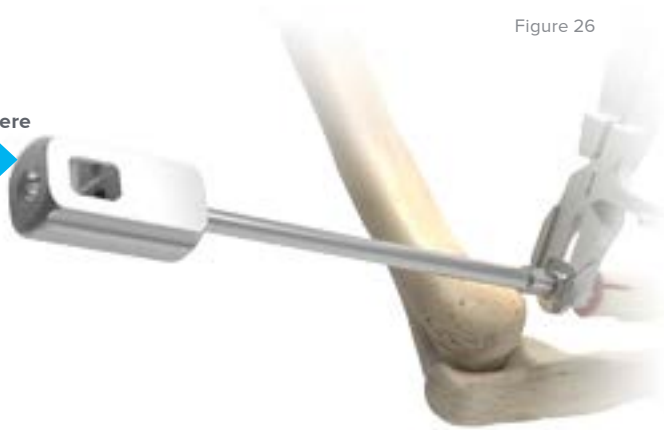

### 10C Insert Implant Stem

1. Insert the non-grit-blasted portion of the ARH Slide-Loc Standard Stem (5001-01XXN-S) into the canal.
2. Rotate and align the laser mark on the stem or ARH Slide-Loc Stem Clamp (80-2538) with Lister's tubercle.
3. Fully seat the stem by impacting the ARH Slide-Loc Stem Inserter (80-1357) until the stem's base is flush with the cut surface of the radius.
4. Use fluoroscopy to verify the stem's base is flush with the cut surface of the radius. The clamp's jaws are in the same plane as the stem. Therefore, if the clamp's jaws are flush with the radial canal's surface or cut, the stem is also flush (Figure 27).
5. Remove the inserter once the stem is definitively inserted.

**Warning:** When using the mallet, hit the handle of the stem inserter, rather than the stem clamp. This preserves the connection with the stem by preventing the speed wheel from loosening, along with the integrity of the instrument (Figure 26).

Proximal End of Clamp Jaws

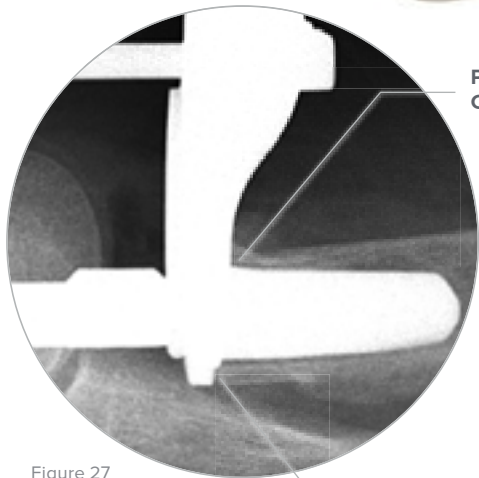

Figure 27

Distal End of Clamp Jaws



ARH Slide-Loc Stem Clamp (80-2538)



ARH Slide-Loc Standard Stem (5001-01XXN-S)



ARH Slide-Loc Stem Inserter (80-1357)



## Standard Stem *In Situ* Surgical Technique [continued]

### 10D Install the Head and Neck Implant Assembly

Select the ARH Slide-Loc Locking Guide that matches the corresponding neck trial and neck implant: +1 (80-2542), +3 (80-2543), or +5 (80-2544). Align the Locking Guide's arrow with the arrow on the ARH Slide-Loc Stem Clamp's (80-2538) arm (Figure 28). Squeeze the locking guide's clip (Figure 29) and slide the locking guide's rail onto the Stem Clamp's arm (Figure 28). Release the clip when the guide is completely on the arm and engaged with the stem clamp.

1. While slightly retracting the radius with the stem clamp, slide the implant head/neck assembly completely onto the implant stem's rails (Figure 34). The shaft of the ARH Slide-Loc Head Assembly Tool (80-1511) should remain parallel with the ARH Slide-Loc Stem Clamp's jaws (Figure 31). This helps ensure the proper engagement between the implant neck and stem.
2. Advance the head/neck assembly until the head assembly tool's collar clears the ARH Slide-Loc Locking Guide (Figure 36). This indicates that the head/neck assembly is fully seated on the stem and allows for proper locking.

**Note:** Pronating or supinating the forearm may aid with sliding the head/neck assembly onto the stem's rails.

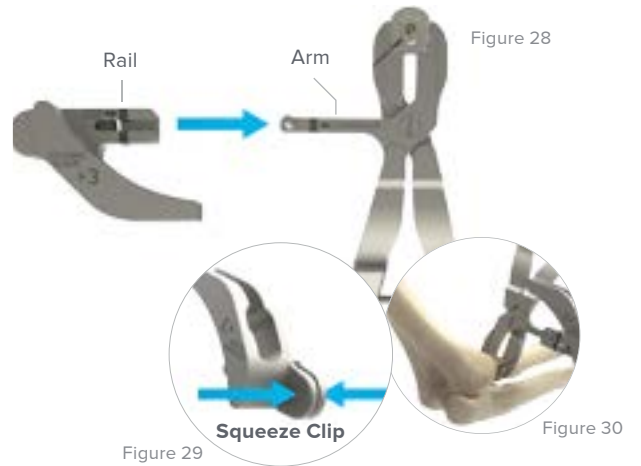

Correctly Aligned

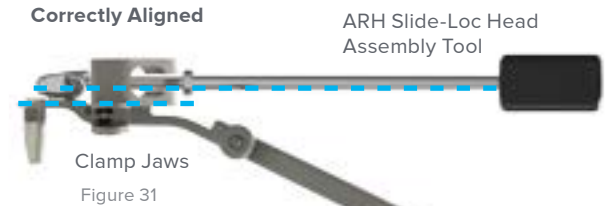

Misaligned



Assembly Tool Collar

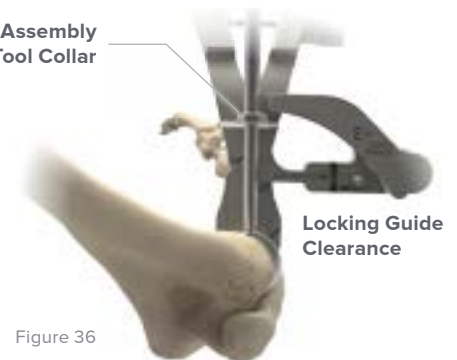

ARH Slide-Loc Locking Guide (80-254X)



ARH Slide-Loc Stem Clamp (80-2538)



ARH Slide-Loc Head (5001-02XXX-S)



ARH Slide-Loc Head Assembly Tool (80-1511)

## Standard Stem *In Situ* Surgical Technique [continued]

Figure 37



### 10E Locking the Head/Neck to the Stem Implant

1. Slightly retract the radius with the ARH Slide-Loc Stem Clamp (80-2538) to ensure that the head/neck assembly remains fully seated on the implant stem's rails.
2. Rotate the ARH Slide-Loc Head Assembly Tool (80-1511) toward the clamp's post, ensuring the head assembly tool's shaft remains in the locking guide's slot (Figure 37). The head/neck is locked to the stem implant when the head assembly tool's shaft contacts the clamp's post. The head assembly tool bounces back slightly after the shaft contacts the post.
3. Unscrew the head assembly tool to remove it from the implant head.

**Caution:** DO NOT rotate the ARH Slide-Loc Stem Clamp. Rotating the stem clamp may change the position of the stem in the radial canal and take it out of anatomic alignment.

**Warning:** The Morse taper and rotational locking mechanisms are designed to be engaged a maximum of **two** times. Engaging the taper and locking mechanisms more than twice may compromise the locking strength.



ARH Slide-Loc Stem Clamp (80-2538)



ARH Slide-Loc Locking Guide (80-254X)



ARH Slide-Loc Head Assembly Tool (80-1511)

## Standard Stem *In Situ* Surgical Technique [continued]

### 11 Confirm Implant Alignment

1. The head/neck laser lines will align with the laser line of the ARH Slide-Loc Stem Clamp (80-2538) when rotated into position. Confirm that the head/neck laser lines are aligned with each other and with the cautery marking. The corner of the stem may also be used as a reference rather than the cautery marking.
2. Loosen the speed lock wheel to remove the clamp from the stem.
3. Pronate and supinate the forearm to ensure that the neck is fully seated against the stem.

**Caution:** Misaligned laser marks may indicate incomplete locking of components (figures 41 and 44). If there is misalignment, repeat the assembly and implantation process (steps 10A and/or 10D) and then reconfirm alignment.

**Warning:** The Morse taper and rotational locking mechanisms are designed to be engaged a maximum of **two** times. Engaging the taper and locking mechanisms more than twice may compromise the locking strength.

Correctly Aligned

Figure 38

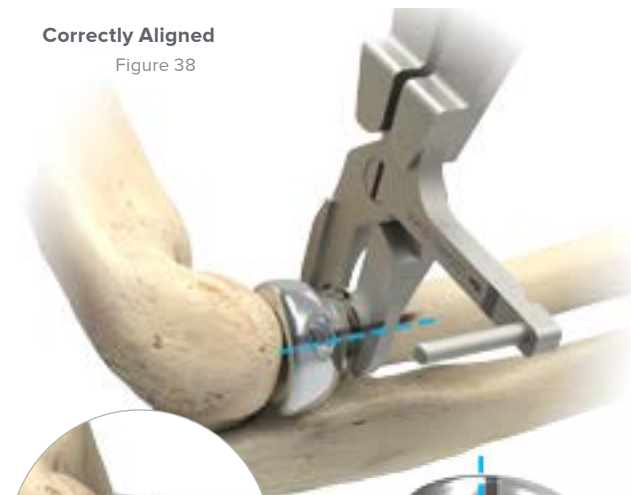

Figure 39



Figure 40

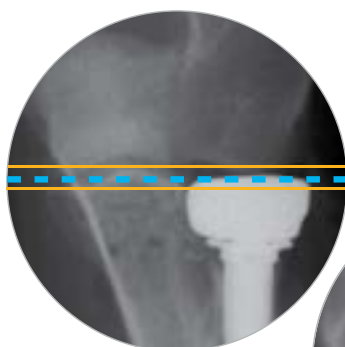

Figure 45



Figure 46

- ▶ Proceed in determining if the implants are the appropriate sizes. Consider using the contralateral X-ray as a reference point.
- ▶ Check for proper articulation with the capitellum and the coronoid (figures 45 and 46). The line along the articular margin of the radial head (blue line) should fall between parallel lines that pass through the central ridge and lateral edge of the coronoid (gold lines).<sup>4</sup>

4. Doornberg, et al. *J Hand Surg Am.* 2006.

Misaligned

Figure 41

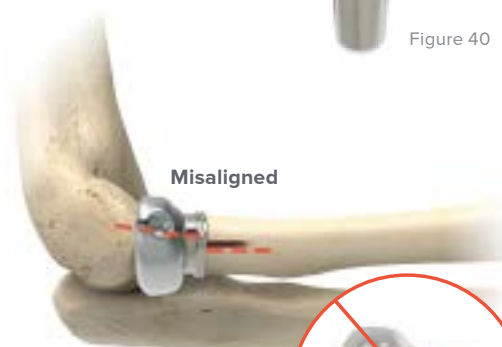

Figure 42

Misaligned

Figure 43

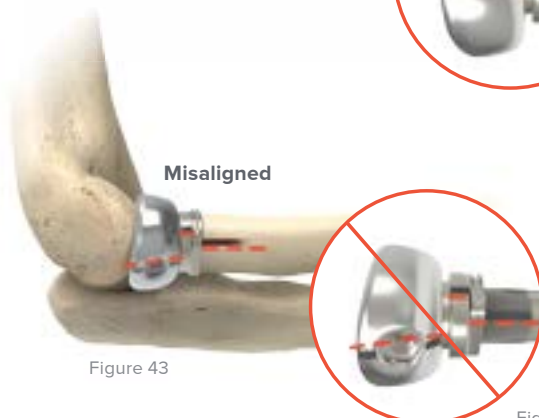

Figure 44



ARH Slide-Loc  
Stem Clamp  
(80-2538)

## Standard Stem *In Situ* Surgical Technique [continued]

### **12** Postoperative Protocol

Postoperative management is determined by the overall management of the elbow and limb, as though the radial head had never been fractured. For isolated fractures of the radial head and neck without ligament injury, early motion is commenced in flexion and extension as well as pronation and supination. This is usually started about three days after surgery.

# Standard Stem *Ex Situ* Surgical Technique

## Part One: Site Preparation and Trialing

The Slide-Loc Anatomic Radial Head System is designed to allow for implanting the head, neck, and stem *in situ*. Depending on the integrity of the lateral soft tissues, it may be preferable to assemble the implant components *ex situ* on the back table and insert them as a one-piece construct.

**FIRST: Complete steps 1-9 (pages 12-19) from the Standard Stem *In Situ* Technique to perform site preparation and trialing.**

Proceed in determining if the trials are the appropriate sizes. Consider using the contralateral X-ray as a reference point. Refer to page 19 of the *in situ* standard stem technique for intraoperative trial x-rays and references for evaluating the appropriate size components.

**Note:** The trial components can also be assembled prior to insertion into the radial canal. Back-table trial assembly can be performed without the use of the ARH Slide-Loc Stem Clamp.

**Caution:** If it is necessary to hit the trial implant assembly to insert it into the radial canal, care must be taken. Impacting the trial components at an angle or non-axial direction may cause the trial neck to become dislodged from the trial stem.

Figure 47

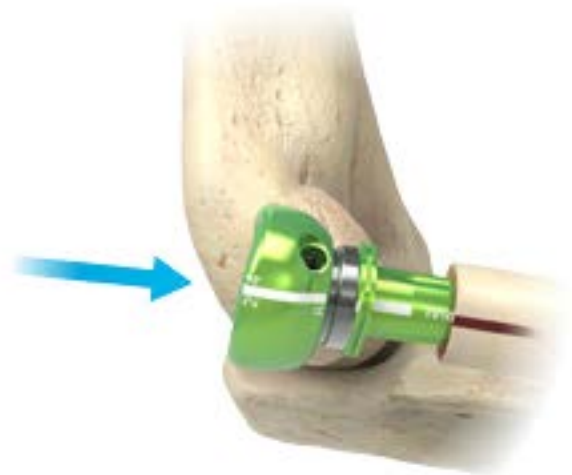

# Standard Stem *Ex Situ* Surgical Technique

## Part Two: Implantation

Figure 48



Figure 49

### 1 Assemble the Implant Head and Neck

Verify the Morse taper interface between the head and neck is clean and dry.

1. Insert the selected ARH Slide-Loc Neck (5001-030XN-S) into the ARH Slide-Loc Head (5001-02XXX-S) with the laser marks on both components aligned.
2. Apply slight pressure to the head/neck assembly while keeping the laser marks aligned to initiate the connection.
3. Place the head and neck on the ARH Slide-Loc Impactor Block (80-1503).
4. Lock the Morse taper using the Head Impactor (TR-MS05) and a mallet. Apply multiple high impact strikes to firmly engage the Morse taper connection.
5. Remove the head/neck assembly.
6. Once the implant head and neck are fully engaged, attach the ARH Slide-Loc Head Assembly Tool (80-1511) to the implant head.

**Note:** To help align the fine threads between the Head Assembly Tool and Implant Head, hold the shaft of the ARH Slide-Loc Head Assembly Tool while turning it clockwise (Figure 50).

**Caution:** The head/neck assembly should be done on a firm surface (ie, avoid using a Mayo stand) to ensure that adequate force is applied to the Morse taper connection.

**Warning:** Incomplete locking between the head and neck may result in disengagement of the components postoperatively.

Figure 50

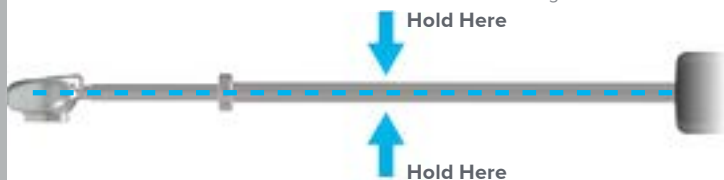

ARH Slide-Loc Neck (5001-030XN-S)



ARH Slide-Loc Head (5001-02XXX-S)



ARH Slide-Loc Impactor Block (80-1503)



Head Impactor (TR-MS05)



Head Assembly Tool (80-1511)

## Standard Stem *Ex Situ* Surgical Technique [continued]

### 2 Prepare the Implant Stem for Back Table Assembly

**Warning:** Properly securing the implant stem to the ARH Slide-Loc Stem Clamp is critical to ensuring the implant stem remains in a fixed or stable position when the implant head/neck assembly is rotated and locked.

Follow the steps below to ensure that the clamp is secured to the stem:

1. Hold the body of the ARH Slide-Loc Standard Stem (5001-01XXN-S) with the thumb and index finger.
2. Attach the ARH Slide-Loc Stem Clamp (80-2538) to the stem by first aligning the stem's laser mark with the clamp's laser mark.
3. Place the clamp's left jaw into the stem's left groove (Figure 52).
4. Squeeze the clamp's handles until the right jaw engages the stem's right groove (side with two notches) (Figure 53).
5. Verify no gaps exist between the stem's grooves and clamp's jaws. If a gap exists, wiggle the stem's body until the jaws are fully seated in the grooves.
6. Tighten the clamp's speed lock wheel firmly to engage the connection between the clamp and the stem.

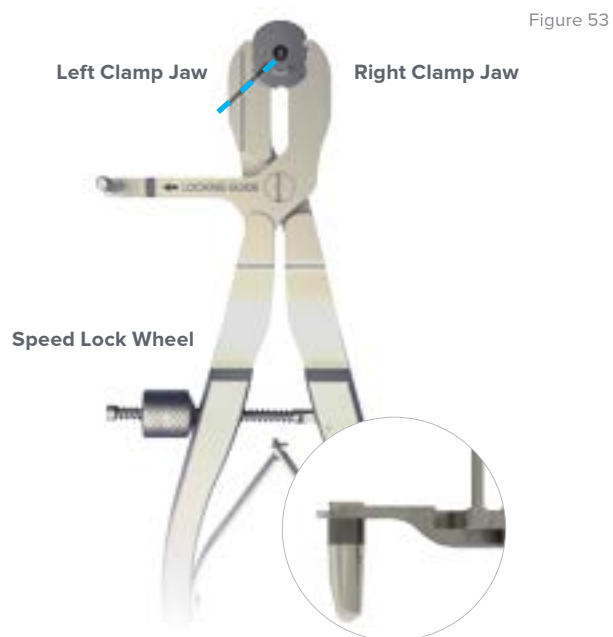
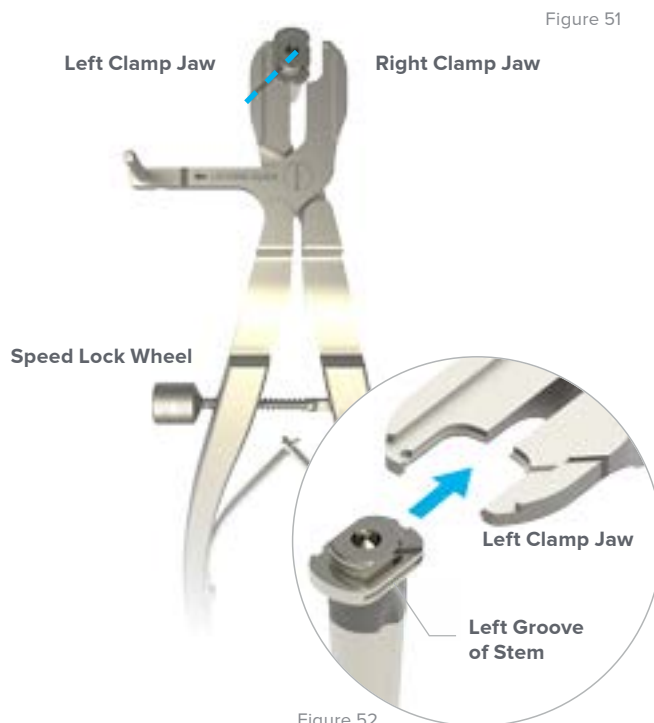

ARH Slide-Loc  
Stem Clamp  
(80-2538)

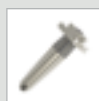

ARH Slide-Loc  
Standard Stem  
(5001-01XXN-S)



ARH Slide-Loc  
Stem Inserter  
(80-1357)

## Standard Stem *Ex Situ* Surgical Technique [continued]

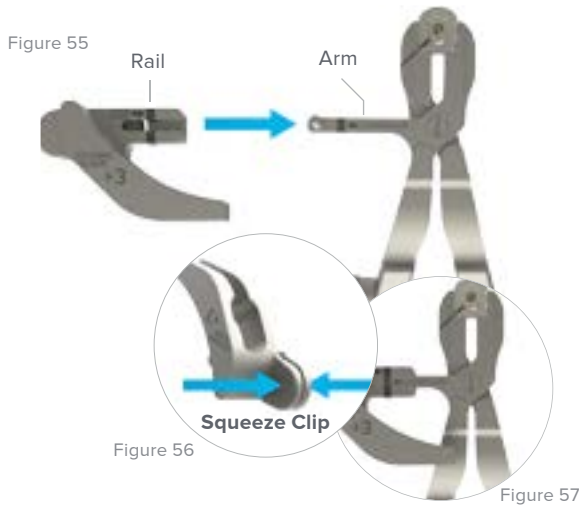

### 3A Install the Head and Neck Assembly

Select the ARH Slide-Loc Locking Guide that matches the corresponding neck trial and neck implant: +1 (80-2542), +3 (80-2543), or +5 (80-2544). Align the Locking Guide's arrow with the arrow on the ARH Slide-Loc Stem Clamp's (80-2538) arm (Figure 55). Squeeze the locking guide's clip (Figure 56) and slide the locking guide's rail onto the Stem Clamp's arm (Figure 55). Release the clip when the guide is completely on the arm and engaged with the stem clamp.

1. Slide the implant head/neck assembly completely onto the implant stem's rails (Figure 61). The shaft of the ARH Slide-Loc Head Assembly Tool (80-1511) should remain parallel with the ARH Slide-Loc Stem Clamp's jaws (Figure 58). This helps ensure the proper engagement between the implant neck and stem.
2. Advance the head/neck assembly until the head assembly tool's collar clears the ARH Slide-Loc Locking Guide (Figure 62). This indicates the head/neck assembly is fully seated on the stem and allows for proper locking.

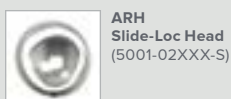
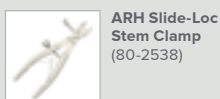
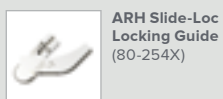
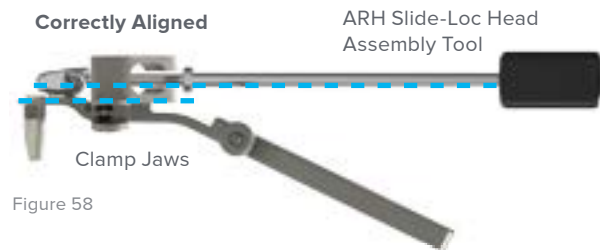



## Standard Stem *Ex Situ* Surgical Technique [continued]

### 3B Lock the Head/Neck to the Stem Implant

Figure 63

1. While holding the ARH Slide-Loc Stem Clamp (80-2538), rotate the ARH Slide-Loc Head Assembly Tool (80-1511) toward the stem clamp's post, ensuring the head assembly tool's shaft remains in the locking guide's slot (Figure 63). The head/neck is locked to the stem implant when the head assembly tool's shaft contacts the clamp's post. The head assembly tool bounces back slightly after the shaft contacts the post.
2. Unscrew the head assembly tool to remove it from the head.
3. Loosen the speed lock wheel to allow removal of the clamp from the stem.

**Note:** The head/neck laser lines will also align with the ARH Slide-Loc Stem Clamp laser line when rotated into position.

Confirm that the head/neck/stem laser lines are aligned with each other (Figure 64).

**Caution:** Misaligned laser marks may indicate incomplete locking of components (figures 65 and 66). If there is misalignment, repeat the assembly process and confirm alignment again before implantation.

**Warning:** The Morse taper and rotational locking mechanisms are designed to be engaged a maximum of **two** times. Engaging the taper and locking mechanisms more than twice may compromise the locking strength.

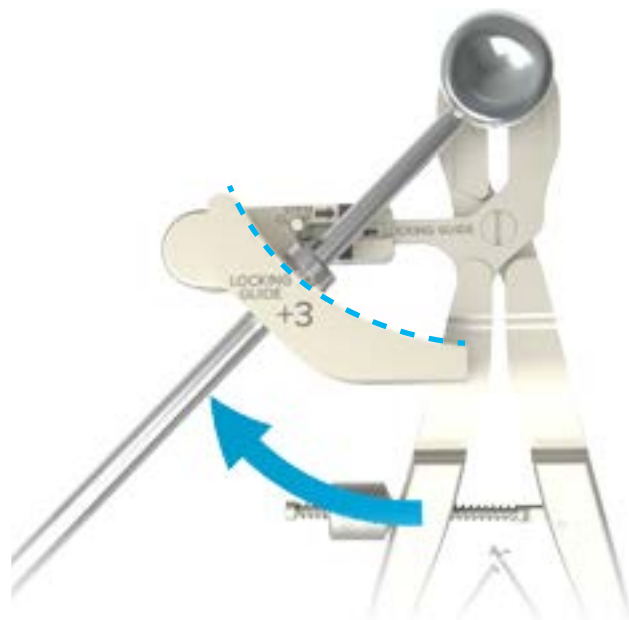

Correctly Aligned

Figure 64



Figure 66

Figure 65



ARH Slide-Loc Stem Clamp (80-2538)



ARH Slide-Loc Locking Guide (80-254X)



ARH Slide-Loc Head Assembly Tool (80-1511)

## Standard Stem *Ex Situ* Surgical Technique [continued]

Figure 67



### 4 Insert the Assembled Implant

Insert the assembled implant into the radius using the Head Impactor (TR-MS05) and a mallet. Ensure that the laser mark on the implant head is aligned with the lateral aspect of the radius when the forearm is in neutral position. Lister's tubercle may also be used as a landmark for laser mark orientation.

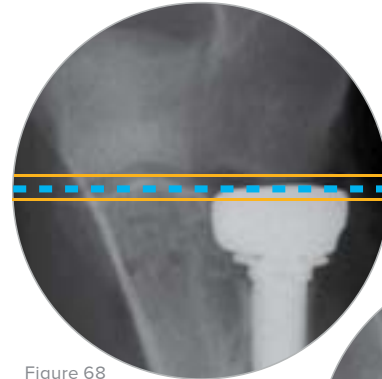

Figure 68



Figure 69

- ▶ Proceed in determining if the implants are the appropriate sizes. Consider using the contralateral X-ray as a reference point.
- ▶ Check for proper articulation with the capitellum and the coronoid (figures 68 and 69). The line along the articular margin of the radial head (blue line) should fall between parallel lines that pass through the central ridge and lateral edge of the coronoid (gold lines).<sup>1</sup>

1. Doornberg JN, Linzel DS, Zurakowski D, Ring D. Reference points for radial head prosthesis size. *J Hand Surg Am.* 2006;31(1):53-57.

### 5 Postoperative Protocol

Postoperative management is determined by the overall management of the elbow and limb, as though the radial head had never been fractured. For isolated fractures of the radial head and neck without ligament injury, early motion is commenced in flexion and extension as well as pronation and supination. This is usually started about three days after surgery.



Head Impactor  
(TR-MS05)

# Long Stem Surgical Technique

## Introduction

This technique typically requires two resection steps to accommodate the 10° neck/shaft angle and proportional change in neck length with stem diameter. The first resection clears a path to insert the reamer and the second resection establishes the appropriate insertion depth for the final stem size. If using the 6 mm stem, only one resection is required. If the reamer's final size is larger than 6 mm (ie 8, 10, or 12 mm), a second cut and subsequent reaming to the instrument's laser mark band accommodates for the respective size of implant stem.

Refer to the table for the amount of resection that corresponds with the long stem's diameter and length.

**Note:** Depending on the integrity of the lateral soft tissues, it may be preferable to implant the Slide-Loc Anatomic Radial Head as a one-piece construct (see the Standard Stem *Ex Situ* technique on page 27).

### Reference Chart

Stem Diameter	Resection Length	Long Stem Length
6 mm	19 mm	50 mm
8 mm	22 mm	55 mm
10 mm	25 mm	60 mm
12 mm	28 mm	65 mm

# Long Stem Surgical Technique [continued]

## Part One: Site Preparation and Trialing

**Warning:** Use of a posterior approach may interfere with *in situ* assembly of the implant.

Figure 70

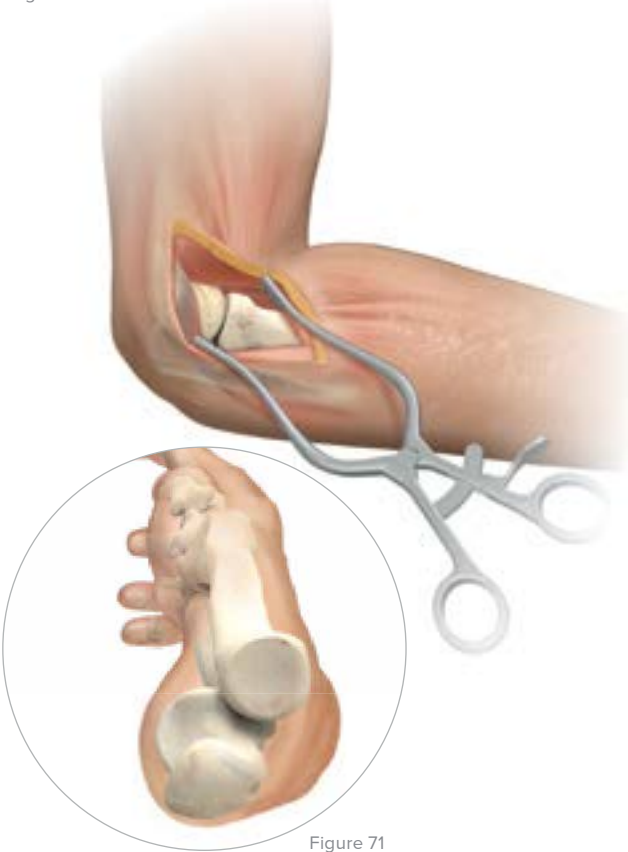

Figure 71

## 1 Incision and Dissection

A hybrid approach may be used to preserve the lateral ulnar collateral ligament (LUCL) and facilitate exposure of the radial head and anterior joint. An incision is made along a line connecting the lateral epicondyle and the equator of the radial head. Proximal dissection is carried along the lateral column of the distal humerus. Distal dissection is carried longitudinally along the radial shaft.

In fracture dislocations, the exposure is through the traumatic opening in the ligament complex. For delayed reconstructions, a Kocher approach is often necessary to adequately sublunate the radius for instrumentation and prosthetic implantation. The Kaplan interval permits the ligament to be left intact. With either approach, the deep incision is placed in a line from the lateral epicondyle toward Lister's tubercle, with the forearm in neutral rotation. Proximally, the extensor longus (ECRL) origin is released with the anterior capsule to permit direct access to the front of the radial head.

With any of these approaches, deep dissection is performed with the forearm in pronation to maximize the distance from the posterior interosseous nerve (PIN). In pronation, the PIN crosses the midpoint of the radial shaft an average of 5.6 cm distal to the capitellum.<sup>1</sup> Furthermore, the PIN has been demonstrated to be within the substance of the supinator muscle 98% of the time.<sup>2</sup> Therefore, common to all exposures, deep dissection includes division of the annular ligament and subsequent exposure of the proximal radial neck. More distal dissection is easily achieved with subperiosteal elevation of the overlying supinator while the forearm is pronated. This method minimizes the potential for structural injury to the PIN.

**Note:** Stem removal can be very difficult if a fully porous, coated surface is well ingrown with bone. Slap hammers and vice grips are useful. After stem removal, find the radial canal distal to the end of the primary stem before reaming. This can be done with a small pointed device such as a Rush reamer. Image intensification can be used to avoid cortical perforation.

1. Calfee RP, Wilson JM, Wong AH. Variations in the anatomic relations of the posterior interosseous nerve associated with proximal forearm trauma. *J Bone Joint Surg Am.* 2011;93(1):81-90.
2. Tornetta P, Hochwald N, Bono C, Grossman M. Anatomy of the posterior interosseous nerve in relation to fixation of the radial head. *Clin Orthop Relat Res.* 1997;345:215-218.

## Long Stem Surgical Technique [continued]

### 2 Radial Head/Neck Resection

1. Place the Long Stem Resection Guide (80-1512) against the capitellum and in line with the radial neck.
2. Score the bone with a blade. If there is no bone at the 6 mm level, then proceed with sequential reaming.
3. Resect at the 6 mm level within the resection guide using an Osteotomy Saw Blade Hub Style L or S (80-0739-S or 80-0740-S) or .6 mm thick blade. This resection level will remove enough neck to allow the reamers to be directly inserted into the radial canal.

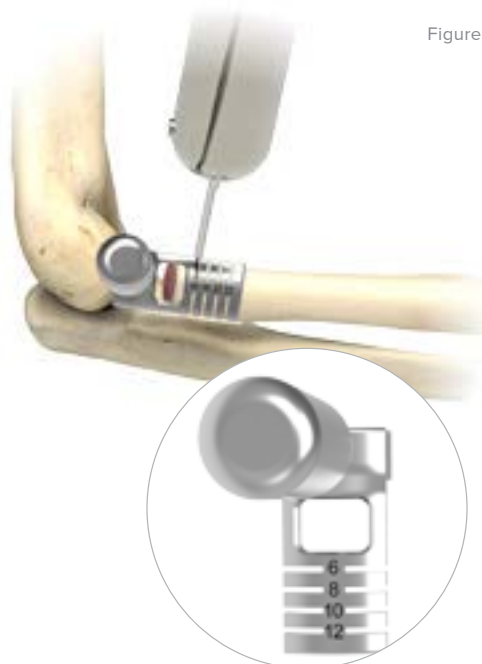

Figure 72

### 3 Ream Canal

The Radius Retractor (80-1509) is available to elevate the radius. Use the 5.5 mm Quick Release Awl (TR-0206) to initially enter the canal.

1. Starting with the 6 mm Long Stem Reamer (80-1706), prepare the canal for the stem using sequentially larger reamers until “cortical chatter” and a tight fit are achieved.
2. If the final reamer diameter size is greater than 6 mm, re-cut the radial neck using the Long Stem Resection Guide and microsagittal saw to the length corresponding to the final reamer diameter size.
3. Re-insert the final size reamer until the laser mark band is even with the level of resection.

**Note:** Confirm the fit by rotating the reamer inside the forearm. If the forearm rotates when the reamer is turned, a sufficiently tight fit has been achieved.

**Warning:** The Long Stem Reamers (80-17XX) are not intended to be used under power. Using them under power may result in over-reaming or fracturing the radial canal.



Figure 74

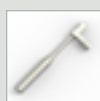

Long Stem Resection Guide (80-1512)



Osteotomy Saw Blade Hub (80-07XX-S)



Radius Retractor (80-1509)



5.5 mm Quick Release Awl (TR-0206)



Long Stem Reamer (80-17XX)

## Long Stem Surgical Technique [continued]

Figure 75



### 4 Determine Head Diameter

Determine the head diameter by placing the resected head upside down in the sizing pockets on the ARH Slide-Loc Impactor Block (80-1503). If between sizes or if the head fits loosely in the sizing pocket, select one size smaller.

Figure 76

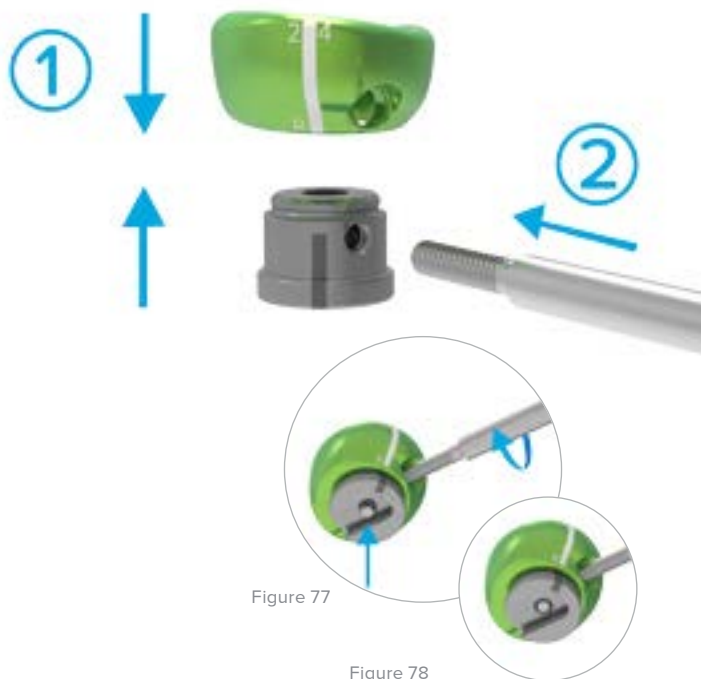

### 5 Select Trial Implant and Assemble

After selecting the ARH Slide-Loc Trial Head (5101-02XXX) and ARH Slide-Loc Trial Neck (5101-03XXN), align the laser marks on the head and neck as shown (Figure 76) and assemble using hand pressure. Attach the ARH Slide-Loc Trial Head Handle (80-2004) to the assembled trial head/neck (Figure 77). The trial head handle retracts the plunger in the trial neck (Figure 78).

**Note:** Left-specific trials are blue and right-specific trials are green.

**Note:** The +3 mm neck matches the resection lengths on the long stem resection guide.

**Caution:** Ensure that the plunger is completely retracted by inserting the trial head handle into the trial neck until fully seated. A partially retracted plunger may prevent the trial neck from sliding onto the trial stem.

**Warning:** Do not install the **trial** head/neck assembly onto the **implant** stem for the purpose of assessing or evaluating the components. Trialing requires the removal of the stem clamp, and reattaching it to the implant stem *in situ* is difficult. Improperly securing the clamp to the implant stem can result in incomplete locking of the head/neck to the stem and may result in disengagement of the components postoperatively.



ARH Slide-Loc Impactor Block (80-1503)



ARH Slide-Loc Trial Head (5101-02XXX)



ARH Slide-Loc Trial Neck (5101-03XXN)



ARH Slide-Loc Trial Head Handle (80-2004)

## Long Stem Surgical Technique [continued]

### 6 Insert Trial Stem

Rotate the forearm to a neutral position. Mark the lateral aspect of the radial neck with the cautery, in line with Lister's tubercle.

Follow the steps below to ensure that the clamp is secured to the stem:

1. Hold the body of the ARH Slide-Loc Trial Long Stem (5101-04XXN) with the thumb and index finger.
2. Attach the ARH Slide-Loc Stem Clamp (80-2538) to the stem by first aligning the stem's laser mark with the clamp's laser mark.
3. Place the clamp's left jaw into the stem's left groove.
4. Squeeze the clamp's handles until the right jaw engages the stem's right groove (side with two notches).
5. Verify no gaps exist between the stem's grooves and the clamp's jaws. If a gap exists, wiggle the stem's body until the jaws are fully seated in the grooves.
6. Tighten the clamp's speed lock wheel firmly to engage the connection between the clamp and the stem.
7. Thread the ARH Slide-Loc Stem Inserter (80-1357) into the stem.

Insert the ARH Slide-Loc Trial Long Stem (5101-04XXN) into the radius with the laser mark (dotted line) on the stem aligned with the cautery marking on the lateral aspect of the radius and subsequently with Lister's tubercle. The ARH Slide-Loc Stem Inserter should be used to aid in stem insertion. Insert the trial stem until the laser mark (solid band) is flush with the canal's surface or cut. The diameter of the trial long stem matches the diameter of the corresponding reamer.

**Caution:** Do not impact the trial long stem into the canal. If the trial cannot be placed at the insertion line without impaction, then recheck the reaming depth or resection cut.

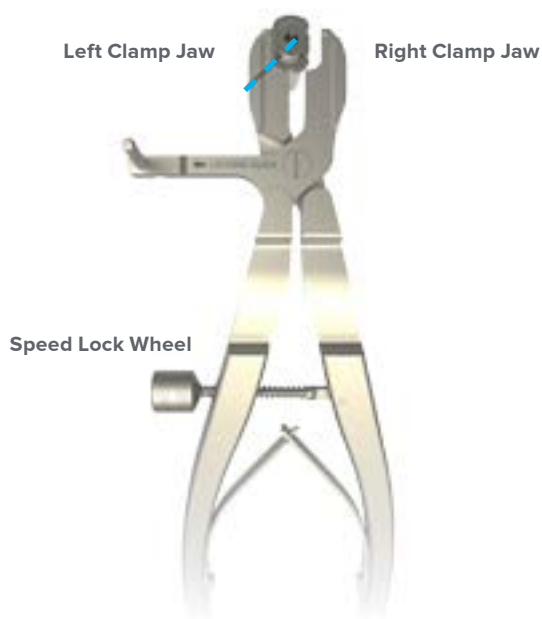

Figure 79

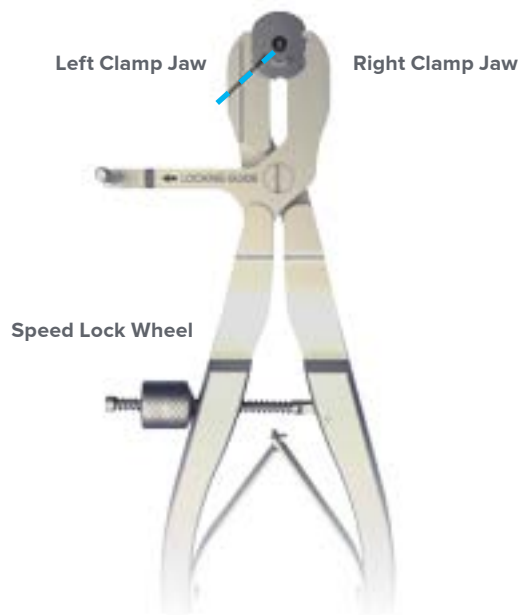

Figure 80



ARH Slide-Loc  
Stem Clamp  
(80-2538)



ARH Slide-Loc  
Stem Inserter  
(80-1357)



ARH Slide-Loc  
Trial Long Stem  
(5101-04XXN)

## Long Stem Surgical Technique [continued]

Figure 81

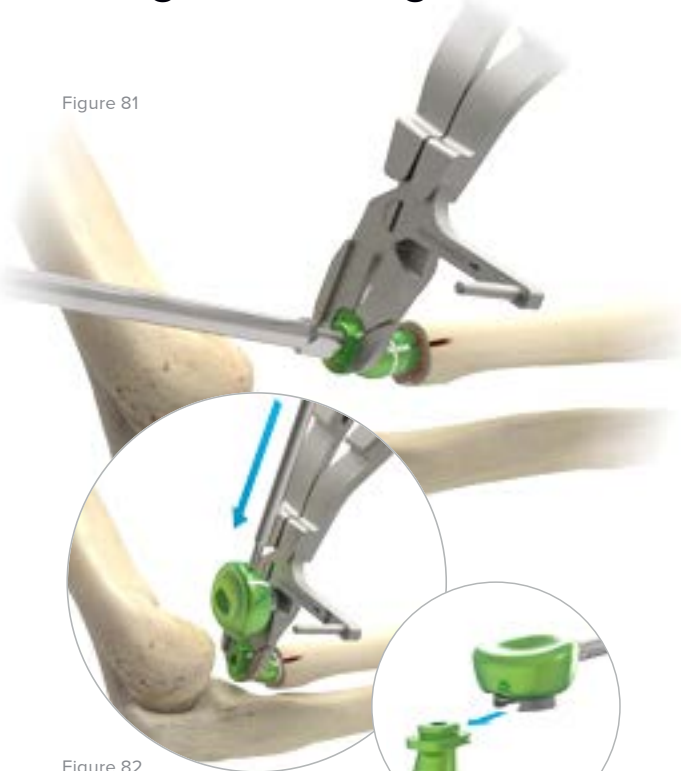

Figure 82

Figure 83

### 7 Attach Trial Head/Neck to Trial Stem

Slide the trial head/neck assembly onto the trial stem. Position the ARH Slide-Loc Trial Head Handle (80-2004) so the shaft is parallel with the ARH Slide-Loc Stem Clamp's jaws (Figure 84), then slide the trial head/neck assembly completely onto the trial stem's rails. This reduces the risk of the trial neck's plunger not engaging with the trial stem's base. Next, unthread the trial head handle to engage the trial neck's plunger in the trial stem for provisional fixation. While unthreading the trial head handle from the trial head/neck assembly, apply axial (downward) pressure on the trial stem. This helps ensure it remains fully seated and the trial neck's plunger properly engages the trial stem.

**Note:** If the +3 mm neck does not provide proper articulation with the capitellum and coronoid, a +1 mm or +5 mm neck may be used to adjust accordingly.

**Caution:** DO NOT rotate the trial head/neck assembly (Figure 86). Doing so **will damage** the trial head, neck, and handle to the point that the components are unusable.

Proceed in determining if the trials are the appropriate sizes. Consider using the contralateral X-ray as a reference point.

**Warning:** Trial components are NOT designed to be implanted.

#### Correctly Aligned

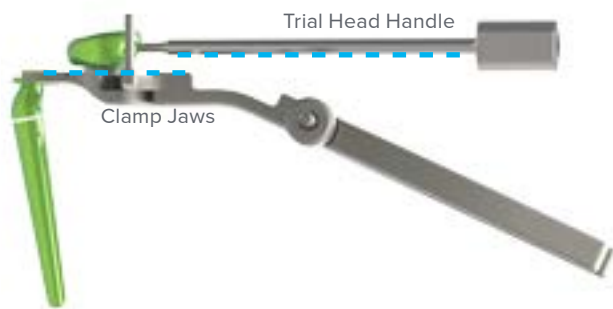

Figure 84

#### Misaligned

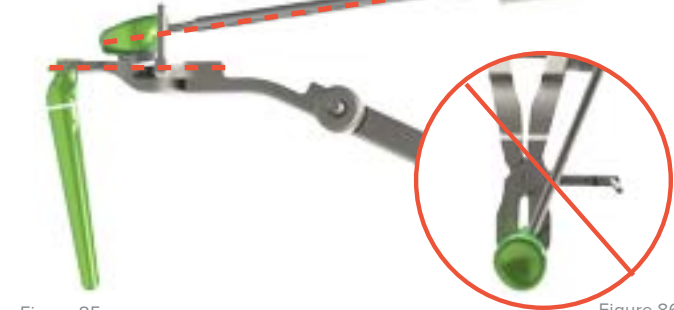

Figure 85

Figure 86



ARH Slide-Loc Trial Head Handle (80-2004)



ARH Slide-Loc Stem Clamp (80-2538)



ARH Slide-Loc Trial Head (5101-02XXX)



ARH Slide-Loc Trial Neck (5101-03XXN)



ARH Slide-Loc Stem Inserter (80-1357)



# Long Stem Surgical Technique [continued]

## Part Two: Implantation

### 8A Assemble the Implant Head and Neck

Verify the Morse taper interface between the head and neck is clean and dry.

1. Insert the selected ARH Slide-Loc Neck (5001-030XN-S) into the ARH Slide-Loc Head (5001-02XXX-S) with the laser marks on both components aligned.
2. Apply slight pressure to the head/neck assembly while keeping the laser marks aligned to initiate the connection.
3. Place the head and neck on the ARH Slide-Loc Impactor Block (80-1503).
4. Lock the Morse taper using the Head Impactor (TR-MS05) and a mallet. Apply multiple high impact strikes to firmly engage the Morse taper connection.
5. Remove the head/neck assembly.
6. Once the implant head and neck are fully engaged, attach the ARH Slide-Loc Head Assembly Tool (80-1511) to the implant head.

**Note:** To help align the fine threads between the head assembly tool and the implant head, hold the shaft of the head assembly tool while turning it clockwise (Figure 89).

**Caution:** The head/neck assembly should be done on a firm surface (ie, avoid using a Mayo stand) to ensure that adequate force is applied to the Morse taper connection.

**Warning:** Incomplete mating of the head and neck may result in disengagement of the components postoperatively.

Figure 87



Figure 88

Figure 89

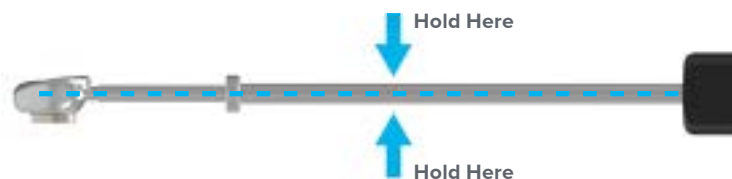

ARH  
Slide-Loc Neck  
(5001-030XN-S)



ARH  
Slide-Loc Head  
(5001-02XXX-S)



ARH Slide-Loc  
Impactor Block  
(80-1503)



Head Impactor  
(TR-MS05)



ARH Slide-Loc  
Head Assembly  
Tool  
(80-1511)

## Long Stem Surgical Technique [continued]

Figure 90

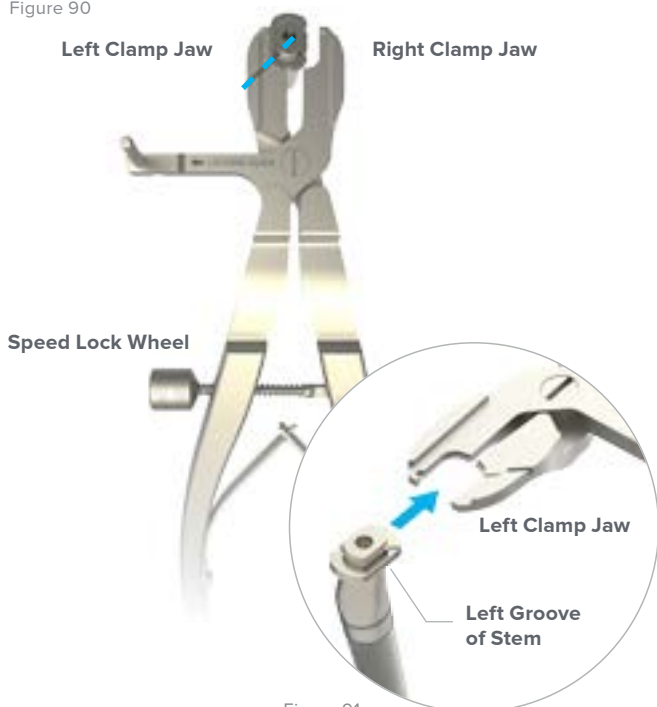

Figure 91

Figure 92

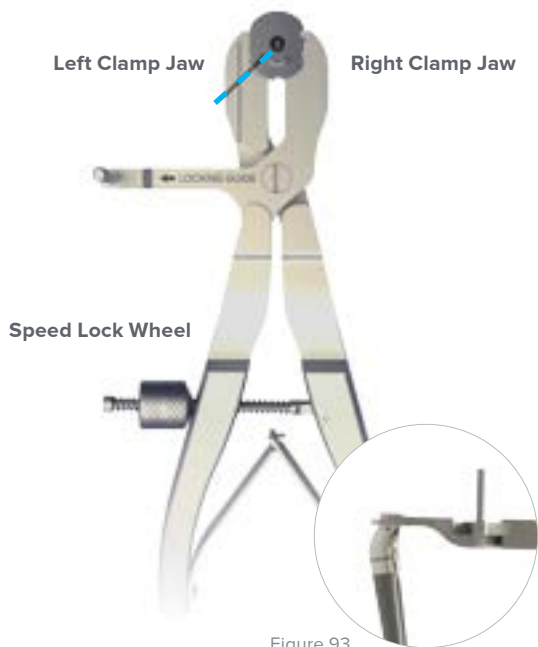

Figure 93

### 8B Prepare Stem for Implantation

**Warning:** Properly securing the implant stem to the clamp is critical to ensuring the implant stem remains in a fixed or stable position when the implant head/neck assembly is rotated and locked.

Follow the steps below to ensure that the clamp is secured to the stem:

1. Hold the body of the ARH Slide-Loc Long Stem (5001-04XXX-S) with thumb and index finger.
2. Attach the ARH Slide-Loc Stem Clamp (80-2538) to the stem by first aligning the stem's laser mark with the clamp's laser mark.
3. Place the clamp's left jaw into the stem's left groove (Figure 91).
4. Squeeze the clamp's handles until the right jaw engages the stem's right groove (side with two notches) (Figure 92).
5. Verify no gaps exist between the stem's grooves and the clamp's jaws. If a gap exists, wiggle the stem's body until the jaws are fully seated in the grooves.
6. Tighten the clamp's speed lock wheel firmly to engage the connection between the clamp and the stem.
7. Thread the ARH Slide-Loc Stem Inserter (80-1357) into the stem.



ARH Slide-Loc Long Stem (5001-04XXX-S)



ARH Slide-Loc Stem Clamp (80-2538)



ARH Slide-Loc Stem Inserter (80-1357)

## Long Stem Surgical Technique [continued]

### 8C Insert Implant Stem

1. Insert the non-grit-blasted portion of the stem into the canal.
2. Rotate and align the laser mark (dotted line) on the stem or clamp with Lister's tubercle.
3. Fully seat the stem by impacting the inserter until the stem's laser mark (solid band) is flush with the cut surface of the radius.
4. Remove the inserter once the stem is definitively inserted.

The long stem implants are 0.25 mm larger than the reamers and trials.

**Warning:** When using the mallet, hit the handle of the stem inserter, rather than the stem clamp. This preserves the connection with the stem by preventing the speed wheel from loosening, along with the integrity of the instrument (Figure 94).

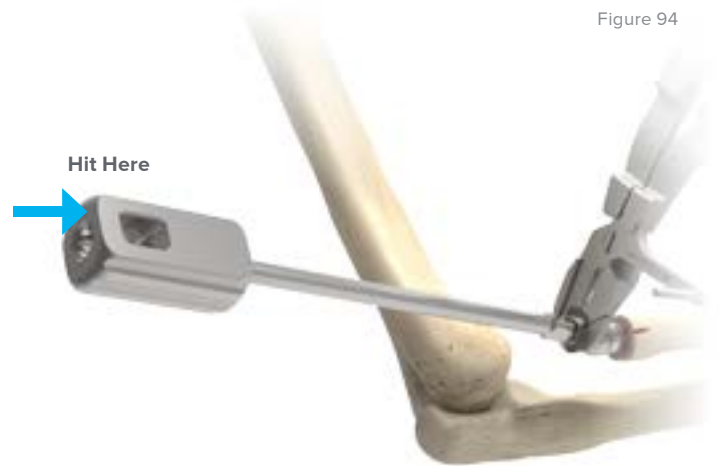

Figure 94



ARH Slide-Loc  
Stem Clamp  
(80-2538)



ARH Slide-Loc  
Long Stem  
(5001-04XXX-S)



ARH Slide-Loc  
Stem Inserter  
(80-1357)

## Long Stem Surgical Technique [continued]

Figure 95

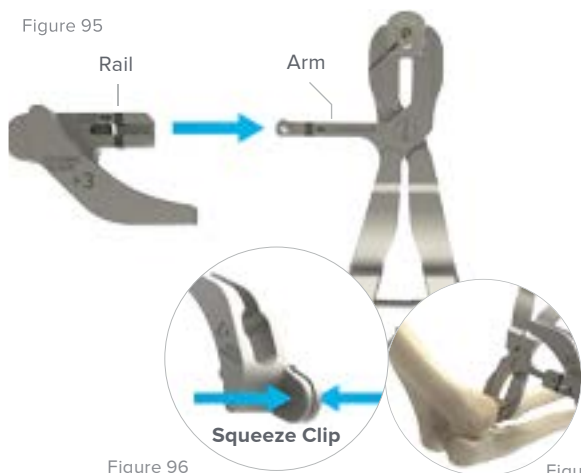

Figure 96

Figure 97

### 8D Install the Head and Neck Implant Assembly

Select the ARH Slide-Loc Locking Guide that matches the corresponding neck trial and neck implant: +1 (80-2542), +3 (80-2543), or +5 (80-2544). Align the Locking Guide's arrow with the arrow on the ARH Slide-Loc Stem Clamp's (80-2538) arm (Figure 95). Squeeze the locking guide's clip (Figure 96) and slide the locking guide's rail onto the Stem Clamp's arm (Figure 95). Release the clip when the guide is completely on the arm and engaged with the stem clamp.

1. Slide the implant head/neck assembly completely onto the implant stem's rails (Figure 101). The shaft of the ARH Slide-Loc Head Assembly Tool (80-1511) should remain parallel with the ARH Slide-Loc Stem Clamp's jaws (Figure 98). This helps ensure proper engagement between the implant neck and stem.
2. Advance the head/neck assembly until the head assembly tool's collar clears the ARH Slide-Loc Locking Guide. This indicates the head/neck assembly is fully seated on the stem and allows for proper locking (Figure 103).

**Note:** Pronating or supinating the forearm may aid with sliding the head/neck assembly onto the stem's rails.

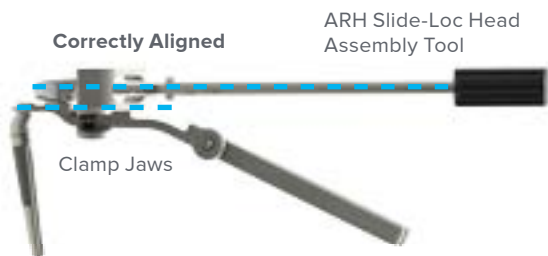
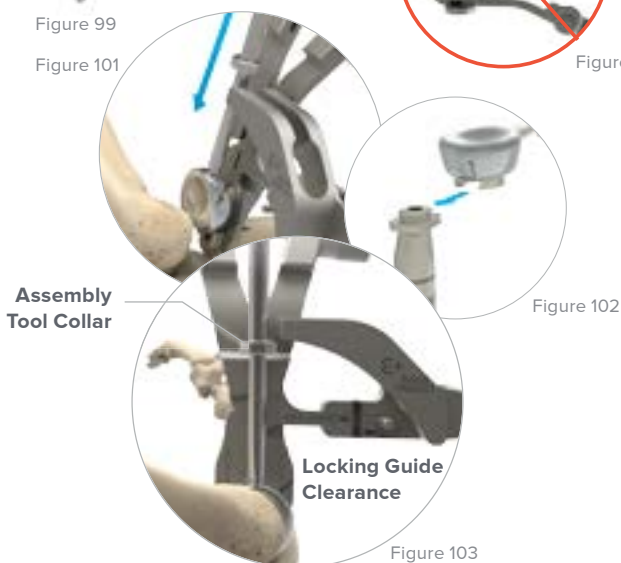

Figure 98



Figure 99

Figure 100



Assembly Tool Collar

Figure 102

Figure 103



ARH Slide-Loc Locking Guide (80-254X)



ARH Slide-Loc Head Assembly Tool (80-1511)



ARH Slide-Loc Stem Clamp (80-2538)

## Long Stem Surgical Technique [continued]

### 8E Locking the Head/Neck to the Stem Implant

1. Slightly retract the radius with the ARH Slide-Loc Stem Clamp (80-2358) to aid in fully seating the head/neck assembly on the implant stem's rails.
2. Rotate the ARH Slide-Loc Head Assembly Tool (80-1511) toward the clamp's post, ensuring the head assembly tool's shaft remains in the locking guide's slot (Figure 104). The head/neck is locked to the stem implant when the head assembly tool's shaft contacts the clamp's post. The head assembly tool bounces back slightly after the shaft contacts the post.
3. Unscrew the head assembly tool to remove it from the implant head.
4. Loosen the speed lock wheel to allow removal of the clamp from the stem.
5. Pronate and supinate the forearm to ensure that the neck is fully seated against the stem.

**Caution:** DO NOT rotate the ARH Slide-Loc Stem Clamp. Rotating the stem clamp may change the position of the stem in the radial canal and take it out of anatomic alignment.

**Warning:** The Morse taper and rotational locking mechanisms are designed to be engaged a maximum of **two** times. Engaging the taper and locking mechanisms more than twice may compromise the locking strength.



Figure 104



ARH Slide-Loc  
Stem Clamp  
(80-2358)



ARH Slide-Loc  
Head Assembly  
Tool  
(80-1511)

## Long Stem Surgical Technique [continued]

Figure 105

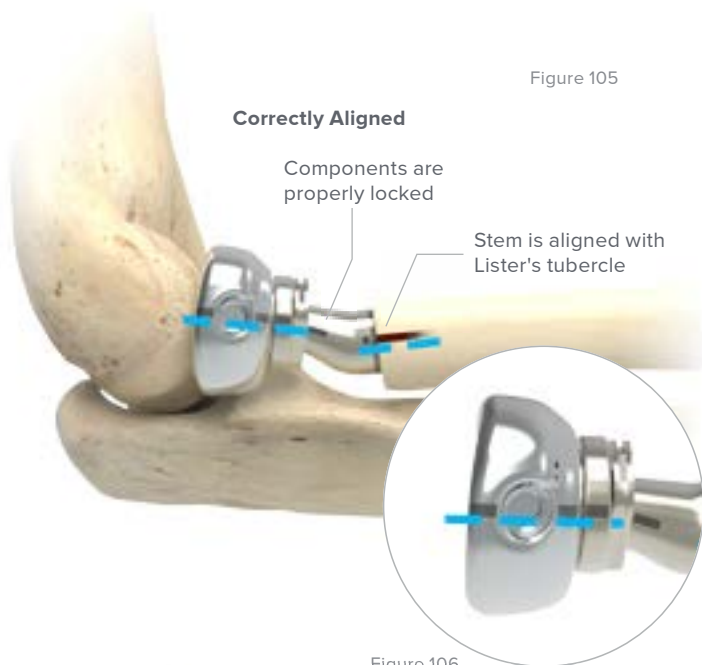

Figure 106

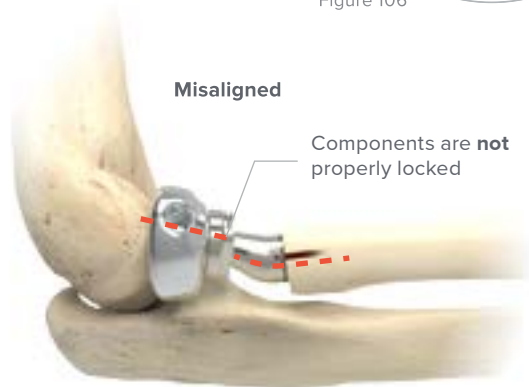

Figure 107

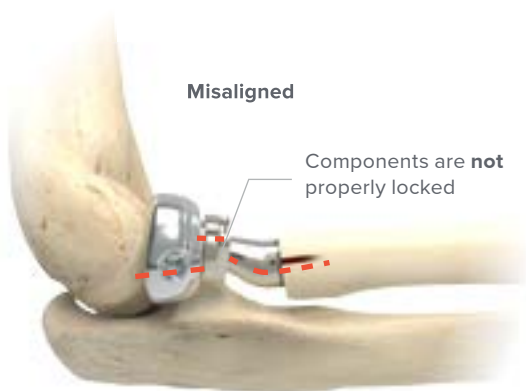

Figure 108

### 9 Confirm Implant Alignment

Confirm that the head, neck and stem laser lines are aligned with each other. The head/neck laser lines will also align with the ARH Slide-Loc Stem Clamp laser line when rotated into position.

**Caution:** Misaligned laser marks may indicate incomplete locking of components (figures 107 and 108). If there is misalignment, repeat the assembly and implantation process (steps 8A and/or 8D) and then reconfirm alignment.

**Warning:** The Morse taper and rotational locking mechanisms are designed to be engaged a maximum of **two** times. Engaging the taper and locking mechanisms more than twice may compromise the locking strength.

Proceed in confirming the implants are the appropriate sizes. Consider using the contralateral X-ray as a reference point. Refer to page 25, figures 45 and 46 in the standard stem in situ technique, for intraoperative implant X-rays and references for evaluating the appropriate size components.

### 10 Postoperative Protocol

Postoperative management is determined by the overall management of the elbow and limb, as though the radial head had never been fractured. For isolated fractures of the radial head and neck without ligament injury, early motion is commenced in flexion and extension as well as pronation and supination. This is usually started about three days after surgery.

# Head, Neck, and Stem Removal Surgical Technique

## 1 Implant Head/Neck Removal

**Note:** This technique applies to both standard and long stems.

To remove the implant head/neck assembly, insert the ARH Slide-Loc Stem Clamp (80-2538) into the groove on the stem. Then attach the ARH Slide-Loc Head Assembly Tool (80-1511) to the head. While holding the stem clamp in place, rotate the head assembly tool approximately 45 degrees counterclockwise away from the locked position until the shaft of the head assembly tool is parallel to the stem clamp. Pull the head/neck assembly away from the stem.

To separate the implant head from the neck, thread the ARH Slide-Loc Trial Head Handle (80-2004) into the neck. Then insert the ARH Slide-Loc Stem Inserter (80-1357) into the trial head handle. While holding on to the head, turn the stem inserter clockwise until the neck disengages from the head. If necessary, insert the Cross Bar (80-1771) through the handle of the stem inserter for increased turning leverage. The ARH Slide-Loc Head Assembly Tool can also be used for additional leverage.

**Note:** The Morse taper and rotational locking mechanisms are designed to be engaged a maximum of **two** times.

**Note:** Should the implant head be removed without the neck, vise grips may be used to rotate the neck off of the stem.

Figure 109

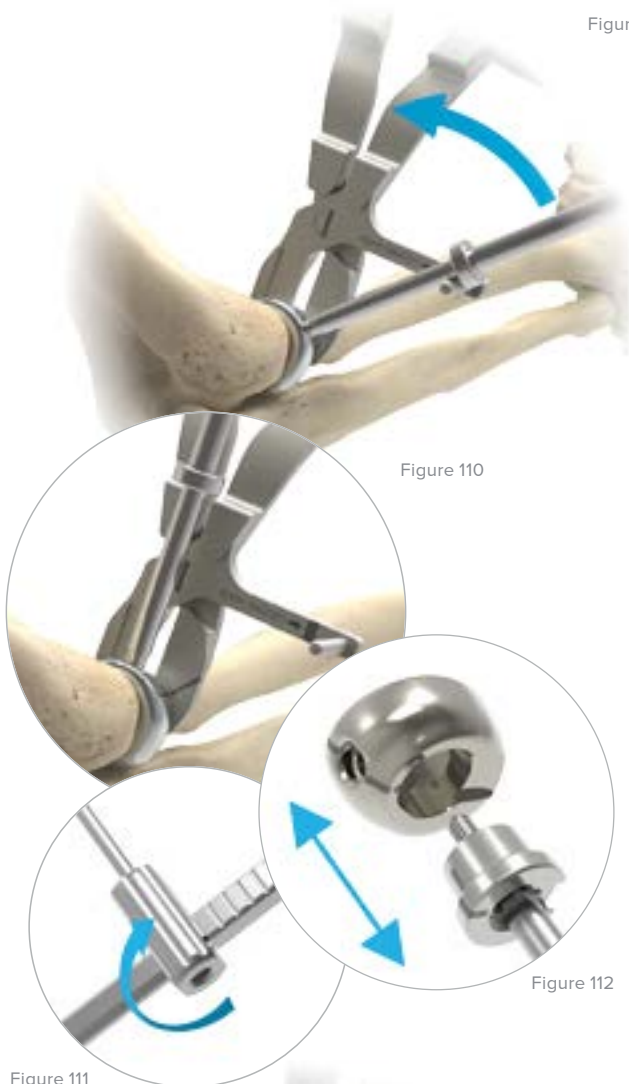

Figure 110

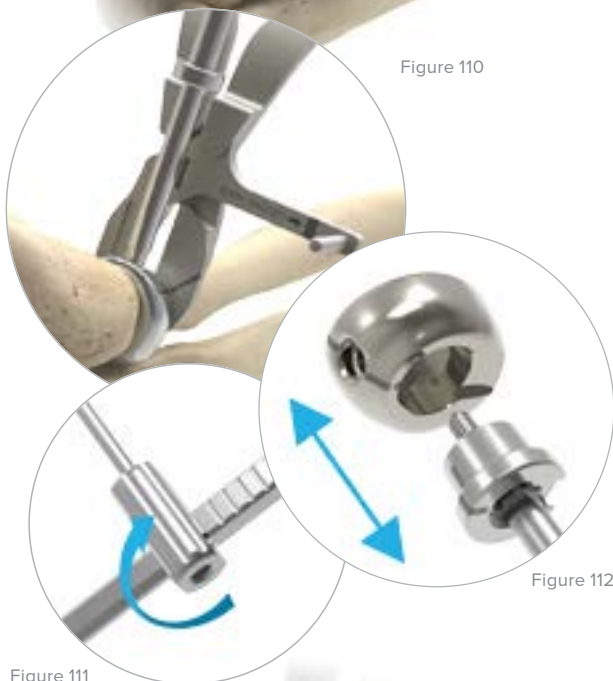

Figure 112

Figure 111



Figure 113

## 2 Implant Stem Removal

To remove the implant stem, thread the ARH Slide-Loc Stem Inserter (80-1357) into the stem. Ensure the inserter is completely threaded into the stem. Insert the Cross Bar (80-1771) through the handle of the stem inserter. Using a mallet, tap the cross bar until the stem is removed.



ARH Slide-Loc Stem Clamp (80-2538)



ARH Slide-Loc Head Assembly Tool (80-1511)



ARH Slide-Loc Trial Head Handle (80-2004)



ARH Slide-Loc Stem Inserter (80-1357)



Cross Bar (80-1771)

# Ordering Information

## Tray Components

### Instruments

1	Standard Stem Reamer 6 mm	80-1606	14	8 mm Collar Reamer	TR-CRA08
2	Standard Stem Reamer 7 mm	80-1607	15	9 mm Collar Reamer	TR-CRA09
3	Standard Stem Reamer 8 mm	80-1608	16	10 mm Collar Reamer	TR-CRA10
4	Standard Stem Reamer 9 mm	80-1609	17	11 mm Collar Reamer	TR-CRA11
5	Standard Stem Reamer 10 mm	80-1610	18	12 mm Collar Reamer	TR-CRA12
6	Standard Stem Reamer 11 mm	80-1611	19	ARH Slide-Loc Impactor Block	80-1503
7	Standard Stem Reamer 12 mm	80-1612	20	5.5 mm Quick Release Awl	TR-0206
8	Long Stem Reamer 6 mm	80-1706	21	Quick Release T-Handle	MS-T1212
9	Long Stem Reamer 8 mm	80-1708	22	Bone Graft Ratcheting T-Handle	BG-8043
10	Long Stem Reamer 10 mm	80-1710	23	ARH Slide-Loc Height Gauge +1 mm	80-1581
11	Long Stem Reamer 12 mm	80-1712	24	ARH Slide-Loc Height Gauge +3 mm	80-1583
12	6 mm Collar Reamer	TR-CRA06	25	ARH Slide-Loc Height Gauge +5 mm	80-1585
13	7 mm Collar Reamer	TR-CRA07			



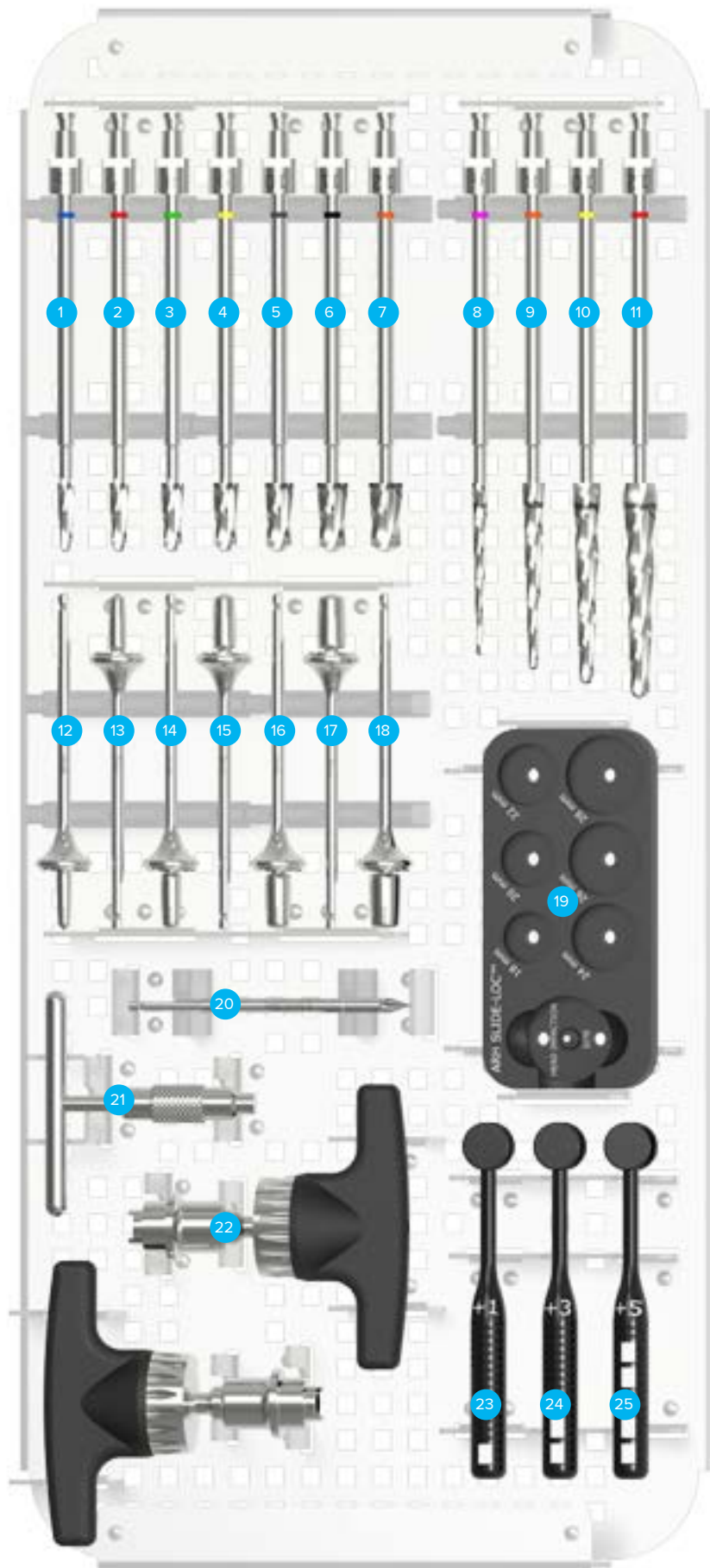

## Ordering Information [continued]

Tray Components		
<b>Instruments</b>		
1	Long Stem Resection Guide	80-1512
2	ARH Slide-Loc Stem Inserter	80-1357
3	ARH Slide-Loc Head Assembly Tool	80-1511
4	Head Impactor	TR-MS05
5	Radius Retractor	80-1509
6	ARH Slide-Loc Stem Clamp	80-2538
7	ARH Slide-Loc Trial Head Handle	80-2004
8	Cross Bar	80-1771
9	ARH Slide-Loc Locking Guide +1 mm	80-2542
10	ARH Slide-Loc Locking Guide +3 mm	80-2543
11	ARH Slide-Loc Locking Guide +5 mm	80-2544
<b>Slide-Loc ARH Neck Trials</b>		
12	ARH Slide-Loc Trial Neck +5 mm	5101-0305N
13	ARH Slide-Loc Trial Neck +3 mm	5101-0303N
14	ARH Slide-Loc Trial Neck +1 mm	5101-0301N
<b>Slide-Loc ARH Long Stem Trials</b>		
15	ARH Slide-Loc Trial Long Stem 6 mm, Left	5101-0406L
16	ARH Slide-Loc Trial Long Stem 8 mm, Left	5101-0408L
17	ARH Slide-Loc Trial Long Stem 10 mm, Left	5101-0410L
18	ARH Slide-Loc Trial Long Stem 12 mm, Left	5101-0412L
19	ARH Slide-Loc Trial Long Stem 6 mm, Right	5101-0406R
20	ARH Slide-Loc Trial Long Stem 8 mm, Right	5101-0408R
20	ARH Slide-Loc Trial Long Stem 10 mm, Right	5101-0410R
21	ARH Slide-Loc Trial Long Stem 12 mm, Right	5101-0412R
<b>Slide-Loc ARH Head Trials</b>		
22	ARH Slide-Loc Trial Head 18 mm, Right	5101-0218R
23	ARH Slide-Loc Trial Head 20 mm, Right	5101-0220R
24	ARH Slide-Loc Trial Head 22 mm, Right	5101-0222R
25	ARH Slide-Loc Trial Head 24 mm, Right	5101-0224R
26	ARH Slide-Loc Trial Head 26 mm, Right	5101-0226R
27	ARH Slide-Loc Trial Head 28 mm, Right	5101-0228R
28	ARH Slide-Loc Trial Head 18 mm, Left	5101-0218L
29	ARH Slide-Loc Trial Head 20 mm, Left	5101-0220L
30	ARH Slide-Loc Trial Head 22 mm, Left	5101-0222L
31	ARH Slide-Loc Trial Head 24 mm, Left	5101-0224L
32	ARH Slide-Loc Trial Head 26 mm, Left	5101-0226L
33	ARH Slide-Loc Trial Head 28 mm, Left	5101-0228L
<b>Slide-Loc ARH Standard Stem Trials</b>		
35	ARH Slide-Loc Trial Standard Stem 6 mm	5101-0106N
36	ARH Slide-Loc Trial Standard Stem 7 mm	5101-0107N
37	ARH Slide-Loc Trial Standard Stem 8 mm	5101-0108N
38	ARH Slide-Loc Trial Standard Stem 9 mm	5101-0109N
39	ARH Slide-Loc Trial Standard Stem 10 mm	5101-0110N
40	ARH Slide-Loc Trial Standard Stem 11 mm	5101-0111N
41	ARH Slide-Loc Trial Standard Stem 12 mm	5101-0112N

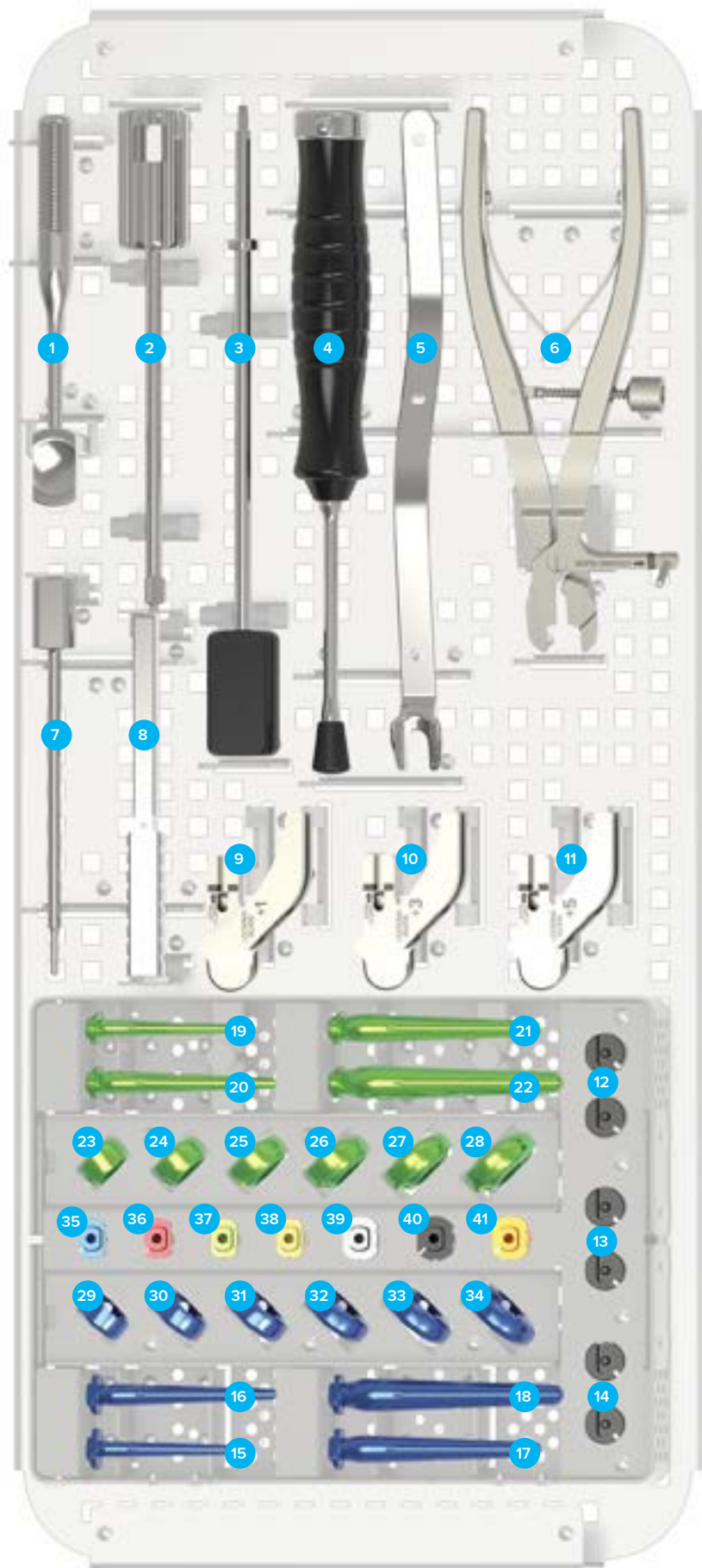

## Ordering Information [continued]

### Other Components

#### Slide-Loc ARH Trays

ARH Slide-Loc Tray Base	80-1514	ARH Slide-Loc Instruments Level 2	80-1517
ARH Slide-Loc Tray Lid	80-1515	ARH Slide-Loc Trial Caddy	80-1518
ARH Slide-Loc Instruments Level 1	80-1516	ARH Slide-Loc Trial Caddy Lid	80-1519

### Sterile Components\*

#### Slide-Loc ARH Head Implants

ARH Slide-Loc Head 18 mm, Left	5001-0218L-S
ARH Slide-Loc Head 20 mm, Left	5001-0220L-S
ARH Slide-Loc Head 22 mm, Left	5001-0222L-S
ARH Slide-Loc Head 24 mm, Left	5001-0224L-S
ARH Slide-Loc Head 26 mm, Left	5001-0226L-S
ARH Slide-Loc Head 28 mm, Left	5001-0228L-S
ARH Slide-Loc Head 18 mm, Right	5001-0218R-S
ARH Slide-Loc Head 20 mm, Right	5001-0220R-S
ARH Slide-Loc Head 22 mm, Right	5001-0222R-S
ARH Slide-Loc Head 24 mm, Right	5001-0224R-S
ARH Slide-Loc Head 26 mm, Right	5001-0226R-S
ARH Slide-Loc Head 28 mm, Right	5001-0228R-S

#### Slide-Loc ARH Neck Implants

ARH Slide-Loc Neck +1 mm	5001-0301N-S
ARH Slide-Loc Neck +3 mm	5001-0303N-S
ARH Slide-Loc Neck +5 mm	5001-0305N-S

#### Slide-Loc ARH Standard Stem Implants

ARH Slide-Loc Standard Stem 6 mm	5001-0106N-S
ARH Slide-Loc Standard Stem 7 mm	5001-0107N-S
ARH Slide-Loc Standard Stem 8 mm	5001-0108N-S
ARH Slide-Loc Standard Stem 9 mm	5001-0109N-S
ARH Slide-Loc Standard Stem 10 mm	5001-0110N-S
ARH Slide-Loc Standard Stem 11 mm	5001-0111N-S
ARH Slide-Loc Standard Stem 12 mm	5001-0112N-S

#### Slide-Loc ARH Long Stem Implants

ARH Slide-Loc Long Stem 6 mm, Left	5001-0406L-S
ARH Slide-Loc Long Stem 8 mm, Left	5001-0408L-S
ARH Slide-Loc Long Stem 10 mm, Left	5001-0410L-S
ARH Slide-Loc Long Stem 12 mm, Left	5001-0412L-S
ARH Slide-Loc Long Stem 6 mm, Right	5001-0406R-S
ARH Slide-Loc Long Stem 8 mm, Right	5001-0408R-S
ARH Slide-Loc Long Stem 10 mm, Right	5001-0410R-S
ARH Slide-Loc Long Stem 12 mm, Right	5001-0412R-S

### Optional Components

Osteotomy Saw Blade Hub Style L	80-0739-S	Osteotomy Saw Blade Hub Style S	80-0740-S
---------------------------------	-----------	---------------------------------	-----------

**\*Please note:** Implants are provided sterile-packed, separate from the system tray.

To learn more about the full line of Acumed innovative surgical solutions, please contact your local Acumed sales representative, call 888.627.9957, or visit [www.acumed.net](http://www.acumed.net).









Acumed Headquarters  
5885 NW Cornelius Pass Road  
Hillsboro, OR 97124  
Office: +1.888.627.9957  
Office: +1.503.627.9957  
Fax: +1.503.520.9618  
[www.acumed.net](http://www.acumed.net)

These materials contain information about products that may or may not be available in any particular country or may be available under different trademarks in different countries. The products may be approved or cleared by governmental regulatory organizations for sale or use with different indications or restrictions in different countries. Products may not be approved for use in all countries. Nothing contained on these materials should be construed as a promotion or solicitation for any product or for the use of any product in a particular way which is not authorized under the laws and regulations of the country where the reader is located. Specific questions physicians may have about the availability and use of the products described on these materials should be directed to their particular local sales representative. Specific questions patients may have about the use of the products described in these materials or the appropriateness for their own conditions should be directed to their own physician.

**ELB10-03-F** | Effective: 2016/10 | © 2016 Acumed® LLC