

## Surgical Technique

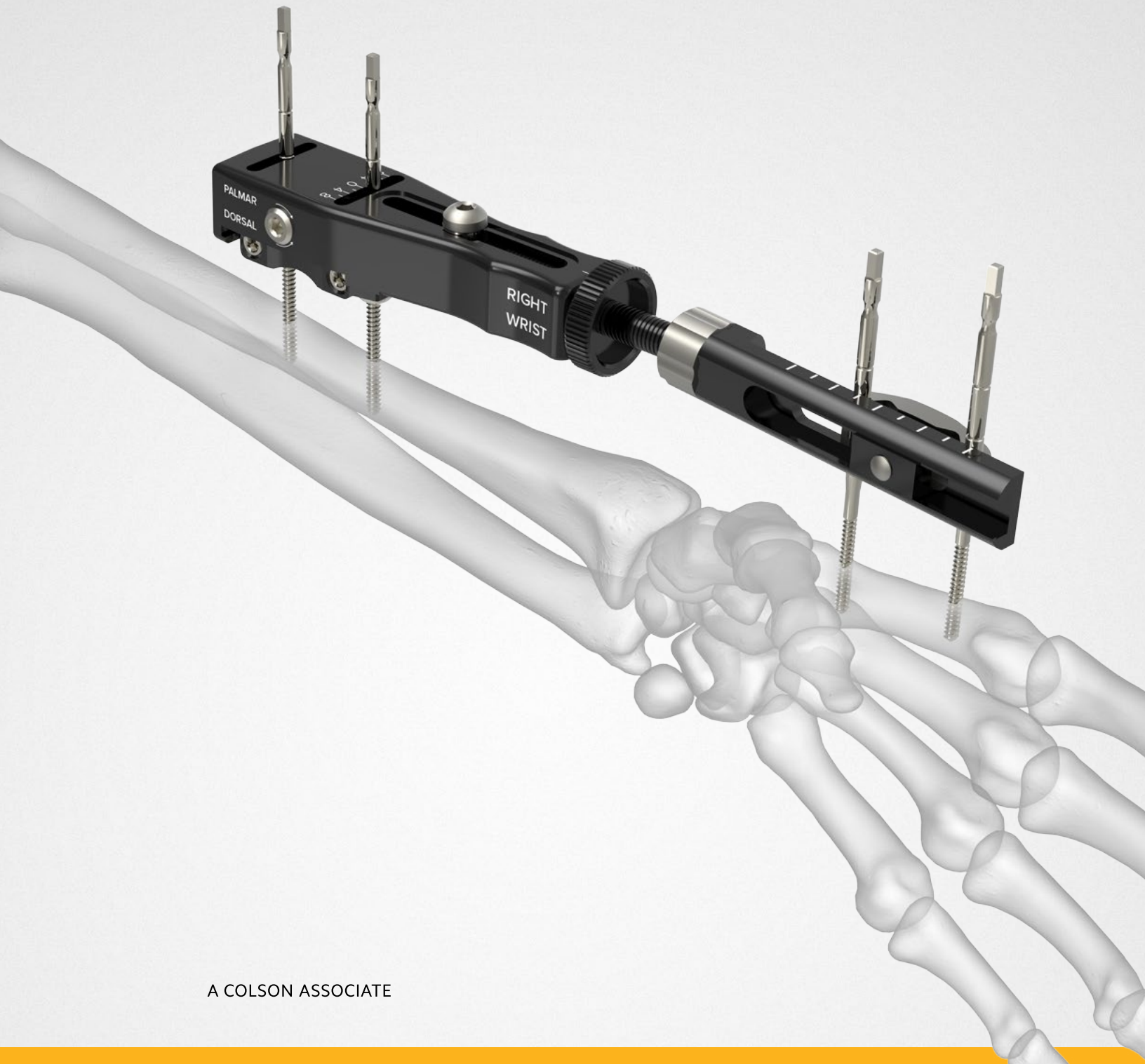

Acumed® is a global leader of innovative orthopaedic and medical solutions.



We are dedicated to developing products, service methods, and approaches that improve patient care.

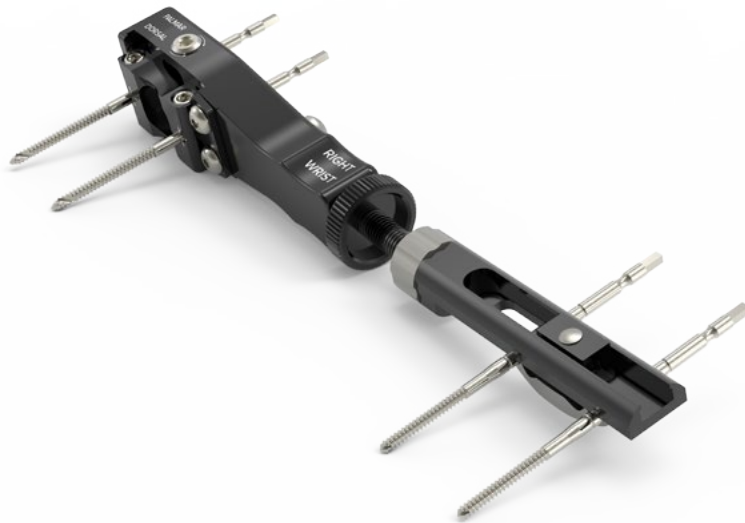

## Acumed® Stableloc External Fixation System

Acumed offers the Stableloc External Fixation System for treatment of complex distal radius fractures. The Stableloc External Fixator is designed to hold pins in place for fracture reduction or distraction to align the wrist, and to provide temporary ligamentotaxis to the wrist while the distal radius heals.

### Indications for Use

The Stableloc External Fixation System is indicated for fixation of Colles fractures and osteotomies of the distal radius. It is not intended for use in the spine. The Stableloc External Fixator is a radiolucent device designed to aid in repairing unstable distal radius fractures. The construct is designed for the surgeon to gain initial reduction with the fixator in place, then independently adjust only those planes needing correction. The system is packaged sterile with all instruments and pins needed to complete a case.

The Stableloc External Fixation System may also be used with the following Acumed products, as applicable. For more information, please refer to the documents listed below:

- ▶ Acu-Loc® 2 Volar Distal Radius Plating System (HNW70-02)
- ▶ Acu-Loc® 2 Wrist Plating System (HNW00-01)
- ▶ Acutrak® System (SPF00-03)
- ▶ Acutrak 2® System (SPF00-02)
- ▶ ARC Wrist Tower System (HNW00-00)
- ▶ Hand Fracture System (HNW10-07)
- ▶ Small Bone External Fixation System (HNW00-02)



	Definition
<b>Warning</b>	Indicates critical information about a potential serious outcome to the patient or the user.
<b>Caution</b>	Indicates instructions that must be followed in order to ensure the proper use of the device.
<b>Note</b>	Indicates information requiring special attention.

# Table of Contents

System Features .....	<b>2</b>
Instrument Overview .....	<b>3</b>
Surgical Technique Overview .....	<b>4</b>
Surgical Techniques .....	<b>6</b>
Stableloc External Fixation System .....	<b>6</b>
Ordering Information .....	<b>11</b>



## System Features

- ▶ The system allows the surgeon to gain initial reduction with the Stableloc External Fixator in place and then independently adjust only those planes needing correction. Adjustments may be made independently for distraction, radial/ulnar deviation, flexion/extension, and dorsal/palmar translation
- ▶ The sterile system includes all instruments and pins needed to complete a case. Self-drilling 3.2 mm pins come standard in the Stableloc kit. Optional sterile, self-drilling 2.7 mm pins are available
- ▶ The Stableloc External Fixator is designed to be lightweight, and its radiolucent body aids visualization during fracture reduction and distraction

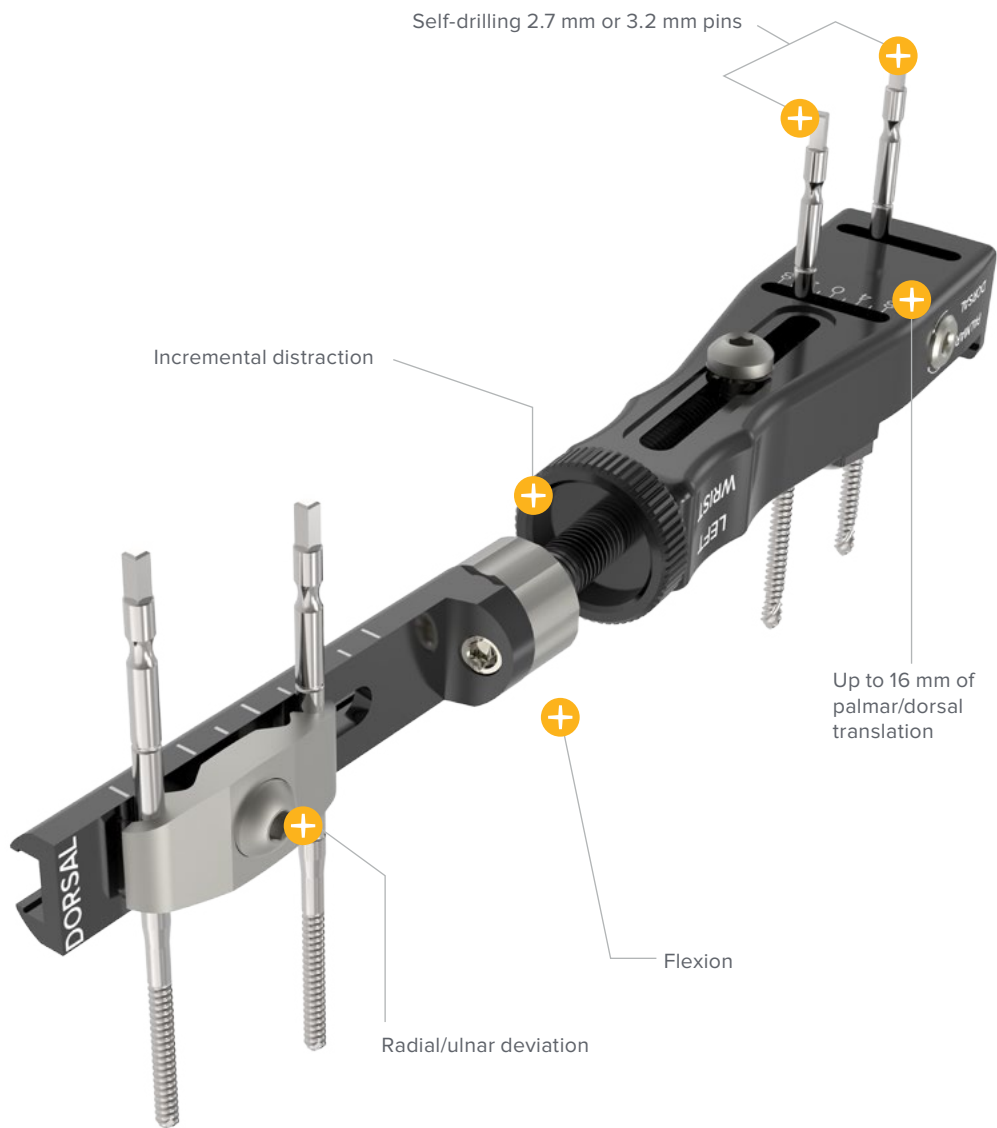

## Instrument Overview



**3.2 mm x 30 mm  
Self-Drilling Pin  
(FX-4004-S)**



**2.7 mm x 25 mm  
Self-Drilling Pin  
(FX-4054-S)**



**Stableloc Hex Driver  
(FX-4003)**



**Stableloc Pin Driver  
(FX-4008)**



**2.5 mm Stableloc Pilot Drill  
(FX-4006)**



**Stableloc 25 mm External  
Drill Guide  
(FX-4002)**



**Stableloc Assembly  
(FX-4000)**

# Surgical Technique Overview

**Stableloc External Fixation System Surgical Technique**

**Presurgical Planning**

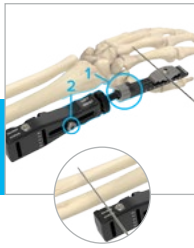

**Insert Distal Fixator Pins**



**Insert Proximal Fixator Pins**

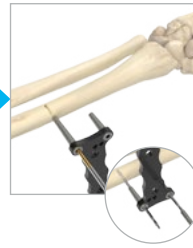

**Apply Stableloc Fixator**

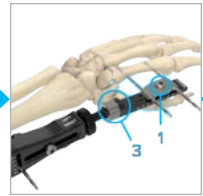

**Distraction/  
Ligamentotaxis**

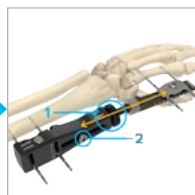

**Dorsal/Palmar  
Translation**

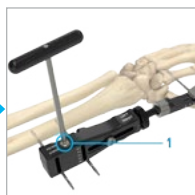

**Radial/Ulnar  
Deviation**



**Flexion/Extension**

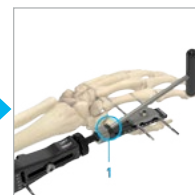

# Stableloc External Fixation System Surgical Technique

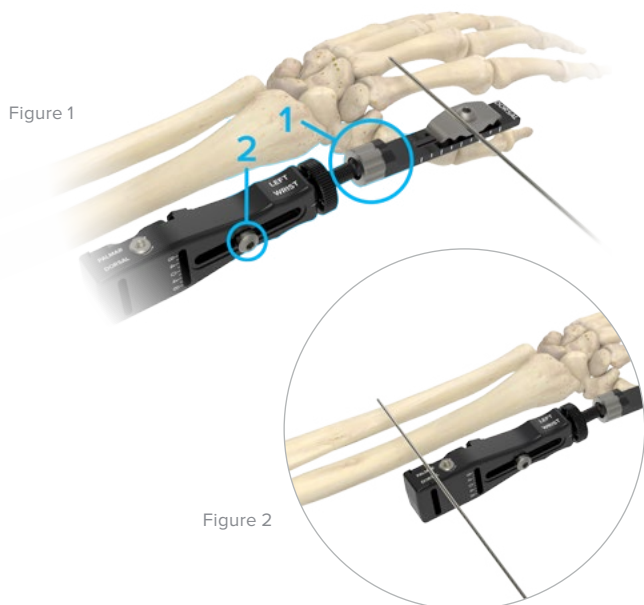

## 1 Presurgical Planning

To determine the proper position of the Stableloc Assembly (FX-4000) in relation to the radius, center of the wrist, and second metacarpal, you must first loosen the ball joint set screw (1) and ball shaft locking screw (2) with the provided Stableloc Hex Driver (FX-4003). Align the Stableloc External Fixator with the extended extremity, lining up the approximate center of wrist rotation with the ball joint. Locate and mark the position of the proximal and distal pins. The Stableloc Fixator should not be fully distracted or fully compressed when determining pin positions.

Placing the Stableloc Fixator in the transverse plane or rotated dorsally up to 20 degrees will increase the accuracy of subsequent adjustments.

**Note:** This step ensures that the Stableloc Fixator Pins (32 mm, FX-4004-S or optional 2.7 mm, FX-4054-S) are placed within the working range of the Stableloc Fixator.

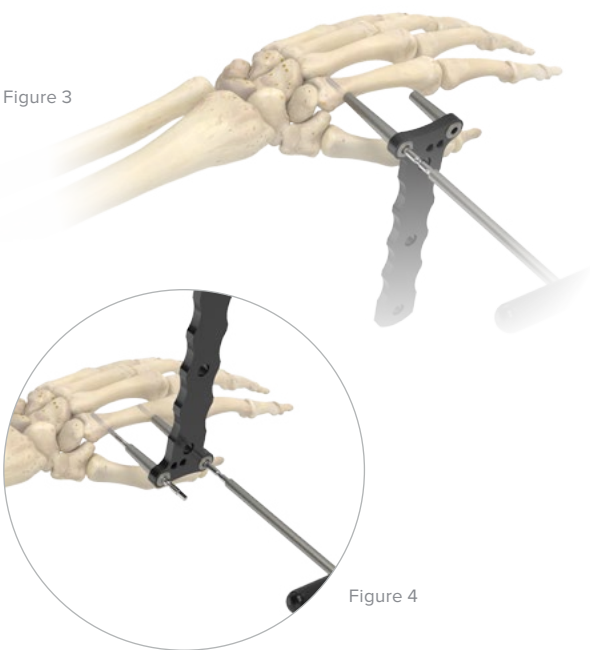

## 2 Insert Distal Fixator Pins

The appropriate incision and dissection steps are carried out. Centering the longer cannula of the Stableloc 25 mm External Drill Guide (FX-4002) on the bone, the first Fixator Pin (32 mm, FX-4004-S or optional 2.7 mm, FX-4054-S) is inserted with the Stableloc Pin Driver (FX-4008) through the base of the second metacarpal and can be extended into the first cortex of the third metacarpal, if desired. Although the Fixator Pins have a self-drilling feature, a 2.5 mm Stableloc Pilot Drill (FX-4006) is provided if predrilling is preferred.

Rotate the Stableloc 25 mm External Drill Guide 180 degrees so the short cannula is placed over the previously inserted Fixator Pin. Making sure the longer cannula is centered on the bone, predrill and insert the second Fixator Pin. Advance the Fixator Pins until two to three threads have extended through the far cortex.

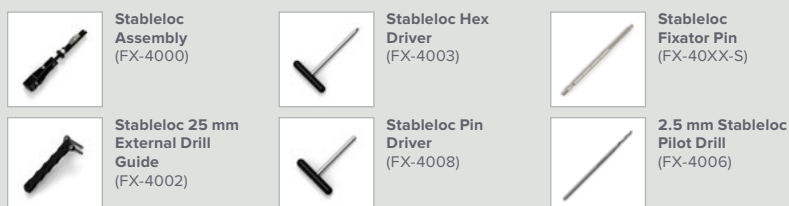



# Stableloc External Fixation System Surgical Technique [continued]

## 3 Insert Proximal Fixator Pins

After incision and careful dissection to the distal radius has been completed, the convex center of the radius is identified. Using the long cannula on the Stableloc 25 mm External Drill Guide (FX-4002), drill bicortically through the radius and insert the first Fixator Pin (32 mm, FX-4004-S or optional 2.7 mm, FX-4054-S). The Fixator Pins may also be used as self-drilling as described earlier. Remove the Stableloc 25 mm External Drill Guide and rotate 180 degrees, placing the shorter cannula over the previously inserted Fixator Pin. Insert the second Fixator Pin in the same manner as the first radius Fixator Pin.

**Note:** Use care when drilling through the radius to avoid overdrilling.



Figure 5



Figure 6

## 4 Apply Stableloc Fixator

Using the Stableloc Hex Driver (FX-4003), loosen the distal pin clamp (Figure 7, 1) and the main body set screws (Figure 8, 2), and slide the Stableloc Assembly (FX-4000) onto the Fixator Pins. Align the Stableloc Fixator on the wrist so the ball joint (3) is positioned over the center of wrist rotation. This will aid in the accuracy of subsequent adjustments.

Lightly tighten the distal pin clamp, the ball shaft locking screw, the ball joint set screw, and the main body set screws, provisionally locking the Stableloc Fixator into position.

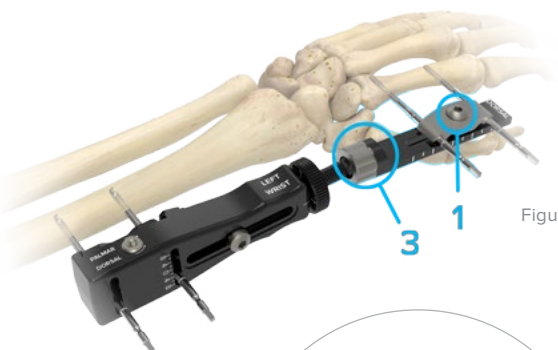

Figure 7

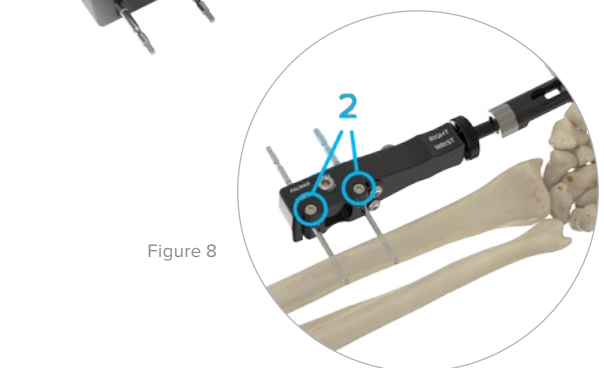

Figure 8



Stableloc 25 mm  
External Drill  
Guide  
(FX-4002)



Stableloc  
Fixator Pin  
(FX-40XX-S)



Stableloc Hex  
Driver  
(FX-4003)



Stableloc  
Assembly  
(FX-4000)

# Stableloc External Fixation System Surgical Technique [continued]

Figure 9

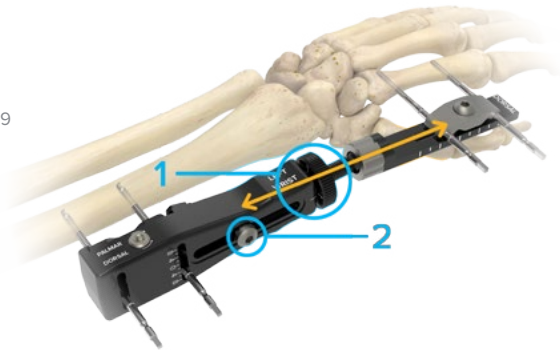

## 5 Distraction/Ligamentotaxis

To apply distraction to the wrist, turn the distraction nut towards the housing to apply the required amount of distraction. One complete revolution of the distraction nut equals 1 mm of distraction (1). Lock the ball shaft locking screw with the Stableloc Hex Driver (FX-4003).

**Note:** The distraction nut is marked with “A,B,C,D” as a reference to indicate where distraction began.

Figure 10

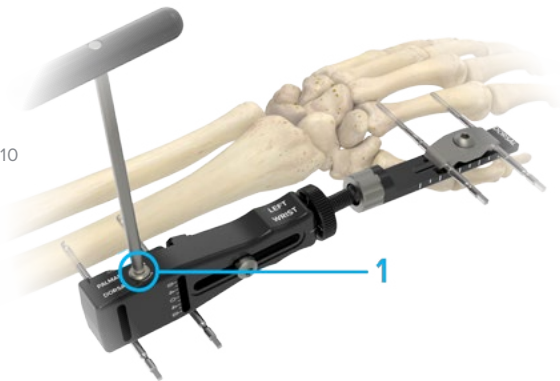

## 6 Dorsal/Palmar Translation

Place the Stableloc Hex Driver (FX-4003) into the jack screw (1) on the dorsal side of the main body of the fixator. Turn the Stableloc Hex Driver clockwise for palmar translation and counterclockwise for dorsal translation. The surgeon can use the scale on the side of the Stableloc Fixator to determine the amount of translation. There are 8 mm of translation available in either direction.



Stableloc Hex Driver  
(FX-4003)

# Stableloc External Fixation System Surgical Technique [continued]

## 7 Radial/Ulnar Deviation

Adjust the radial/ulnar deviation by loosening the distal pin clamp (1). This allows free movement in both the medial/lateral (M/L) and radial/ulnar direction.

**Note:** Traction may be lost when the distal pin clamp locking screw is loosened.



Figure 11

## 8 Flexion/Extension

To achieve the desired angle of wrist flexion: Loosen the ball joint (1), adjust to the flexion desired, then lock the ball joint.

**Caution:** Do not discard the Stableloc Hex Driver (FX-4003) or the Stableloc Pin Driver (FX-4008), as you will need these items for removal of the Stableloc External Fixator.

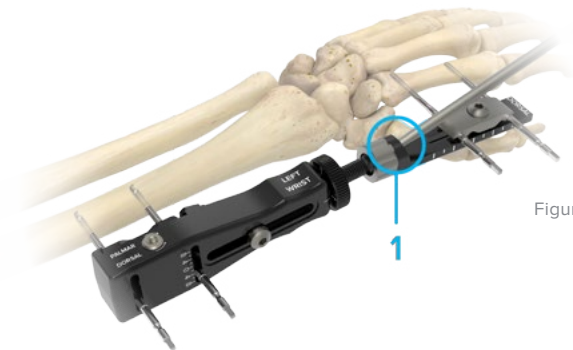

Figure 12

# Stableloc External Fixation System Surgical Technique [continued]

## 9 Postoperative Protocol

Postoperative care is at the discretion of the surgeon. The following protocol is provided as an example.

After completion of all adjustments, the Stableloc External Fixator is locked into its final position. Wounds are dressed based on surgeon preference and dry sterile gauze is recommended to be wrapped around the Fixator Pins (32 mm, FX-4004-S or optional 2.7 mm, FX-4054-S) to prevent pistoning of Fixator Pins and soft tissue. The Stableloc Soc (FX-4005) can then be applied over Stableloc External Fixator Assembly as an option.

**Note:** The Stableloc Hex Driver (FX-4003) may be used for in-office adjustments, and the Stableloc Pin Driver (FX-4008) may be used for pin removal at the appropriate time.

**Caution:** Please save these parts from your sterile procedure pack, as you will need them for removal. Consult the appropriate Instructions for Use for sterilization parameters.

## 10 Implant Removal Instructions

To extract a Stableloc External Fixator, use the Stableloc Hex Driver (FX-4003) to loosen the distal pin clamp and the main body set screws. Remove the Stableloc Assembly.

The Stableloc Pin Driver (FX-4008) can be used to remove the pins.



Stableloc  
Fixator Pin  
(FX-40XX-S)



Stableloc Hex  
Driver  
(FX-4003)



Stableloc Pin  
Driver  
(FX-4008)

## Ordering Information

### Stableloc External Fixator Sterile Procedure Kit

Stableloc External Fixator Kit	FX-4001-S
Stableloc Assembly*	FX-4000
Stableloc 25 mm External Drill Guide*	FX-4002
Stableloc Hex Driver*	FX-4003
2.5 mm Stableloc Pilot Drill*	FX-4006
Stableloc Pin Driver*	FX-4008

### Optional Components

Stableloc Soc*	FX-4005
----------------	---------

### Optional Sterile Components

3.2 mm x 30 Self-Drilling Pin	FX-4004-S (1 each)
2.7 mm x 25 mm Self-Drilling Pin	FX-4054-S (1 each)

\*Included in the Stableloc External Fixator Kit. Not sold individually.

**Note:** To learn more about Acumed's full line of innovative surgical solutions, please contact your authorized Acumed distributor, call 888.627.9957, or visit [www.acumed.net](http://www.acumed.net).







Acumed Headquarters  
5885 NW Cornelius Pass Road  
Hillsboro, OR 97124  
Office: +1.888.627.9957  
Office: +1.503.627.9957  
Fax: +1.503.520.9618  
[www.acumed.net](http://www.acumed.net)

These materials contain information about products that may or may not be available in any particular country or may be available under different trademarks in different countries. The products may be approved or cleared by governmental regulatory organizations for sale or use with different indications or restrictions in different countries. Products may not be approved for use in all countries. Nothing contained on these materials should be construed as a promotion or solicitation for any product or for the use of any product in a particular way which is not authorized under the laws and regulations of the country where the reader is located. Specific questions physicians may have about the availability and use of the products described on these materials should be directed to their particular authorized Acumed distributor. Specific questions patients may have about the use of the products described in these materials or the appropriateness for their own conditions should be directed to their own physician.

**HNW00-02-D** | Effective: 2017/11 | © 2017 Acumed® LLC